

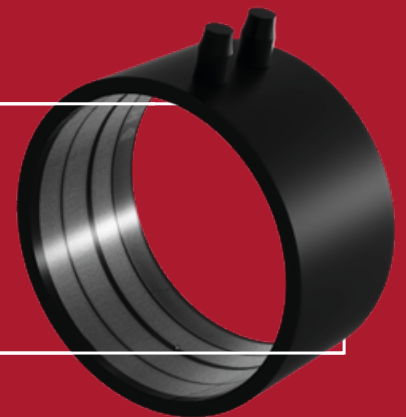

DESIGN & INSTALLATION GUIDE

HDPE
Soil





Crayford, Kent

HDPE Soil

Marley HDPE is a drainage system which offers an alternative solution to cast iron. It is particularly suited for commercial applications or where a product with high impact or abrasion resistance is required, such as hospitals, hotels, schools, as well as residential buildings. Marley HDPE is certified to BS EN 1519. HDPE will also cope with temperature variations of -40°C to 100°C* making it ideal for external as well as internal installations.

*Applications possible between -40°C and 80°C. HDPE is suitable up to 100°C for short periods of time.

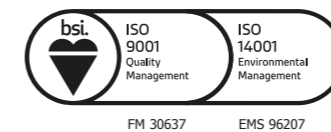

FM 30637

EMS 96207



KM 545820
BS EN 1519

Contents

4	Range overview	36	HDPE bracketry
6	Product specification	50	Typical installations
18	System overview	52	Appendix
20	Material properties	59	Case study
22	Installation	60	HDPE handling and storage
23	HDPE jointing methods	61	Technical services
32	Transitions to other materials	62	British and European standards

INNOVATION
& EXPERTISE

HDPE soil



The HDPE soil range is certified to BS EN 1519: 2000 (licence number KM 545820). An extension of the Marley soil & waste portfolio, the HDPE range offers an alternative solution to cast iron.

It is particularly suited for commercial applications or where a product with high impact or abrasion resistance is required, such as hospitals, hotels, schools, as well as residential buildings.



Key fitting: Stack-aerator

The need for secondary venting in high-rise buildings can be eliminated with the aerator. The unique shape of the HDPE stack-aerator fitting maintains the core of air inside the stack. This keeps the positive and negative pressures within the required limits to prevent trap seal breach, without the requirement of secondary venting. The vent opening between the offset chamber and the entry chamber keeps the horizontal pipe ventilated.

The unique shape of the fitting increases the capacity of the stack allowing the soil and waste flow from the higher floors to smoothly converge with the flow on the lower floor

Features and benefits

- Light weight
- Easy to handle on site
- High impact and temperature resistant
- Abrasion resistant
- Alternative to cast iron
- Provides quick hygeince removal of sanitary waste water
- Secure joints for medium and high rise buildings
- Compatible with the Marley PVCu soil and waste system for branch connection

Key product information

- Size range: 56mm, 75mm, 110mm, 160mm, 200mm, 250mm and 315mm
- Other sizes are available. Speak to Customer Services on 01622 852585 for further information.
- Temperature range: -40°C – 100°C (short term)

Typical applications

- Commercial projects
- Student accommodation
- Hotels
- Apartments
- Hospitals

dBlue Acoustic soil



*16dB at 4 l/s

An acoustic soil range with a layered pipe providing quick, hygienic removal of sanitary waste water. The noise generated by the flow of water is dramatically reduced – making it perfect for multi-occupancy apartment blocks and high specification developments.

Features and benefits

- Light weight
- Easy to handle on site
- 16dB at 4 l/s discharge rate, when using 110mm Phonoklip® bracket
- Secure push-fit jointing system
- Quick and easy to install
- Provides quick and hygienic removal of sanitary waste water
- Dramatically reduce the sound of waste water
- Compatible with the Marley PVCu soil and waste system for branch connection
- High impact and temperature resistant

Key product information

- Size Range: 110mm and 160mm
- Temperature Rating: 95°C (Short term)

Typical applications

Sound attenuated drainage systems in:

- Apartments
- Hotels
- Libraries
- Hospitals
- Public buildings
- Restaurants

PVCu Soil and waste systems

The PVCu soil system is available in 82mm, 110mm and 160mm and the waste system is available in 32mm, 40mm and 50mm sizes. Marley's soil and waste systems have push-fit and solvent weld options incorporating socketed and plain ended pipe.

110mm and 160mm pipe support components have been designed specifically to support horizontal or vertical suspended PVCu pipework.

- Pushfit or solvent weld jointing options
- Quick and easy installation saving time and money
- All collar bosses are individually pressure tested to ensure joint integrity
- Hole-saw locator on all bosses for ease of installation



PIPE

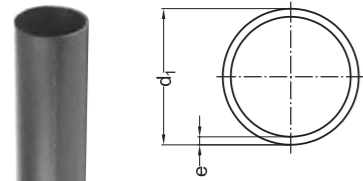

PIPE LENGTH = 5M

d ₁	Code	e	cm ²	Qty	d ₁	Code	e	cm ²	Qty
56	S 10 56 00	3.0	19.60	149	200	S 10 20 00	6.2	276.41	20
75	S 10 07 00	3.0	37.40	81	250	S 10 25 00	7.7	431.52	12
110	S 10 11 00	4.2	80.70	75	315	S 10 31 00	9.7	685.35	10
160	S 10 16 00	6.2	171.10	39					

cm² = cross sectional area of flow
Pipe = Tempered

PIPE LENGTH = 3M

d ₁	Code	e	cm ²	Qty
110	S 10 11 03	4.2	80.70	48

ELECTROFUSION COUPLER

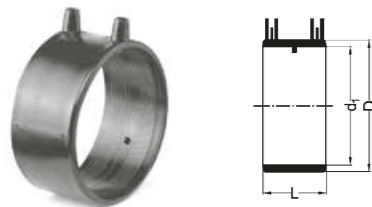

d ₁	Code	D	L	System	Qty	d ₁	Code	D	L	System	Qty
56	S 41 56 95	68	54	5A/80s	20	200	S 41 20 65	233	175	220V/420s	1
75	S 41 07 95	87	54	5A/80s	20	250	S 41 25 65	283	175	220V/420s	1
110	S 41 11 95	123	60	5A/80s	20	315	S 41 31 65	349	175	220V/420s	1
160	S 41 16 95	172	66	5A/80s	5						

EXPANSION SOCKET

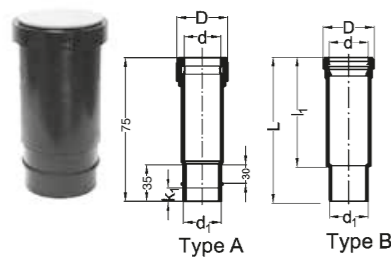

Type A						Type B								
d ₁	Code	D	d	L	Qty	d ₁	Code	D	d	L	I ₁	Qty		
75	S 42 07 20	*	100	76	256	20	56	S 40 56 20	*	74	57	172	135	20
110	S 42 11 20	*	137	112	256	20	200	S 40 20 20	**	230	202	310	245	1
160	S 42 16 20	*	189	162	265	5	250	S 40 25 20	**	300	253	330	265	1
							315	S 40 31 20	**	370	319	360	290	1

Seals: SBR
* Includes protection plug
** Excludes protection plug / Butt-weld only
See page 30 for details on TYPE A / TYPE B

PLUG-IN SOCKET

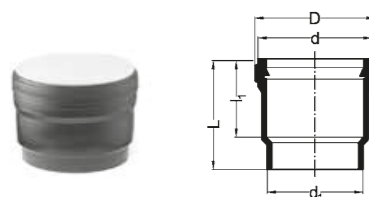

d ₁	Code	D	d	L	I ₁	Qty	d ₁	Code	D	d	L	I ₁	Qty	
56/32	S 42 32 50	56	?	77	38		75	S 42 07 50	96	76	109	69	20	
56/40	S 42 40 50	56	?	75	36		110	S 42 11 50	128	119	101	60	20	
56	S 42 56 50	72	57	89	54	20	160	S 42 16 50	*	190	162	151	105	10

Electrofusible spigot ends
Seals: SBR
Includes protection plug
* Butt-weld only

SOCKET REDUCER



Size mm	Code	A	B	Colour	Qty
56-32	KR310H	32	28	W	40
56-40	KR320H	32	28	W B	40

Solvent spigot/socket
For use with the plug-in socket S 42 56 50

INSPECTION SCREW

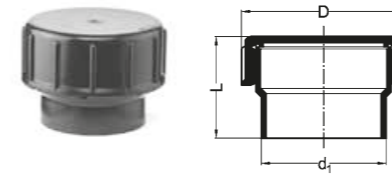

d ₁	Code	D	L	Qty	d ₁	Code	D	L	Qty
56	S 66 56 40	81	74	20	110	S 66 11 40	145	106	10
75	S 66 07 40	111	106	20					

BEND 90° - SHORT

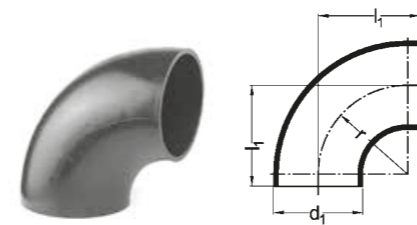

d ₁	Code	l ₁	r	Qty	d ₁	Code	l ₁	r	Qty
160	S 11 16 91	160	160	10	250	S 11 25 91	290	265	1
200	S 11 20 91	205	200	10	315	S 11 31 91	340	300	1

Butt-weld only

BEND 90° - LONG

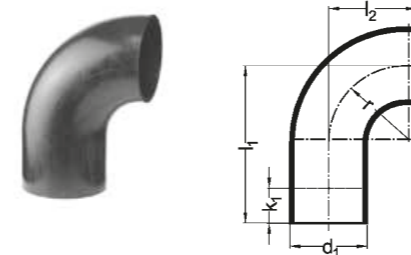

d ₁	Code	l ₁	l ₂	r	k ₁	Qty	d ₁	Code	l ₁	l ₂	r	k ₁	Qty
56	S 11 56 92	120	59	56	55	20	110	S 11 11 96	180	113	110	60	20
75	S 11 07 92	140	78	75	60	25							

Electrofusible at one side

BEND 15°

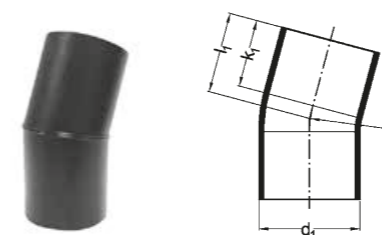

d ₁	Code	l ₁	r	k ₁	Qty	d ₁	Code	l ₁	r	k ₁	Qty
110	S 18 11 15	125	165	65	1	250	S 18 25 15	225	375	135	1
160	S 18 16 15	175	240	100	1	315	S 18 31 15	250	473	175	1
200	S 18 20 15	200	300	125	1						

Fabricated

Additional sizes are available.

For further information, contact our Customer Services department on **01622 852585**

BEND 30°

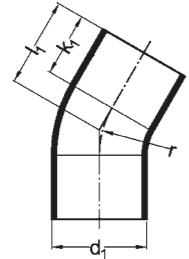

d ₁	Code	l ₁	r	k ₁	Qty
110	S 18 11 30	125	165	60	1
160	S 18 16 30	175	240	100	1
200	S 18 20 30	200	200	115	1

Fabricated

d ₁	Code	l ₁	r	k ₁	Qty
250	S 18 25 30	225	255	125	1
315	S 18 31 30	250	320	135	1

ELBOW 88.5°

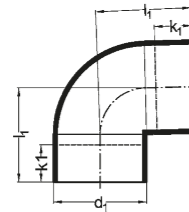

d ₁	Code	l ₁	k ₁	Qty
56	S 12 56 88	65	20	20
75	S 12 07 88	75	20	20
110	S 12 11 88	95	25	20
160	S 12 16 88	120	25	10

*Fabricated

d ₁	Code	l ₁	k ₁	Qty
200	S 12 20 88*	290	60	1
250	S 12 25 88*	350	60	1
315	S 12 31 88*	360	60	1

ELBOW 45° – SHORT

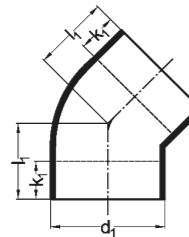

d ₁	Code	l ₁	k ₁	Qty
56	S 12 56 45	45	20	20
75	S 12 07 45	50	20	20
110	S 12 11 45	60	25	20
160	S 12 16 45	69	20	5

d ₁	Code	l ₁	k ₁	Qty
200	S 12 20 45	173	60	5
250	S 12 25 45	182	60	5
315	S 12 31 45	195	60	5

ELBOW 45° – LONG

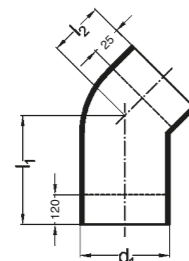

d ₁	Code	l ₁	l ₂	Qty
75	S 12 07 46	145	50	20
110	S 12 11 46	155	60	20

Elbows 45° with long spigot are applied for making the transition from stack to building drain acc. to EN 12056 (see drawing).

- 1 stack
- 2 building drain

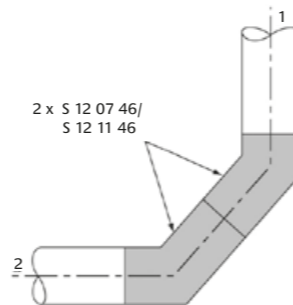

BRANCH 45°

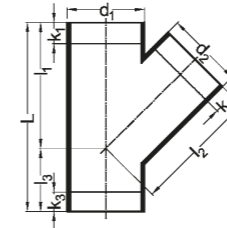

d ₁ , d ₂	Code	L	l ₁ /l ₂	l ₃	k ₁	k ₂	k ₃	Qty
56/56	S 30 56 56	180	120	60	25	25	40	20
75/56	S 30 07 56	210	140	70	35	25	55	20
75/75	S 30 07 07	210	140	70	25	25	40	20
110/56	S 30 11 56	270	180	90	45	40	90	10
110/75	S 30 11 07	270	180	90	35	30	75	10
110/110	S 30 11 11	270	180	90	20	20	55	15
160/56	S 30 16 56	* 375	250	125	120	115	65	5
160/75	S 30 16 07	* 375	250	125	120	115	65	5
160/110	S 30 16 11	375	250	125	50	40	45	5
160/160	S 30 16 16	375	250	125	10	15	25	5
200/75	S 30 20 07	540	360	180	95	160	175	1
200/110	S 30 20 11	540	360	180	65	140	150	1

d ₁ , d ₂	Code	L	l ₁ /l ₂	l ₃	k ₁	k ₂	k ₃	Qty
200/160	S 30 20 16	540	360	180	35	85	115	1
200/200	S 30 20 20	700	430	270	160	160	230	1
250/110	S 30 25 11	* 660	440	220	150	185	215	1
250/160	S 30 25 16	* 660	440	220	120	130	180	1
250/200	S 30 25 20	* 660	440	220	90	50	150	1
250/250	S 30 25 25	* 900	600	300	160	160	250	1
315/110	S 30 31 11	* 840	560	280	235	260	305	1
315/160	S 30 31 16	* 840	560	280	200	205	270	1
315/200	S 30 31 20	* 840	560	280	175	125	240	1
315/250	S 30 31 25	* 840	560	280	140	130	205	1
315/315	S 30 31 31	* 950	610	340	170	170	280	1

* Fabricated

BRANCH 88.5°

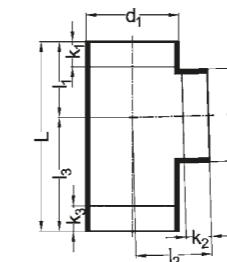

d ₁ , d ₂	Code	L	l ₁ /l ₂	l ₃	k ₁	k ₂	k ₃	Qty
56/56	S 20 56 56	175	70	105	30	30	65	20
75/56	S 20 07 56	175	70	105	30	25	65	20
75/75	S 20 07 07	175	70	105	25	25	55	20
110/56	S 20 11 56	225	90	135	45	25	90	10
110/75	S 20 11 07	225	90	135	35	25	85	10
110/110	S 20 11 11	225	90	135	20	20	65	15
160/56	S 20 16 56	* 350	140	210	75	30	145	5
160/75	S 20 16 07	* 350	140	210	80	45	150	5
160/110	S 20 16 11	350	140	210	60	45	135	5
160/160	S 20 16 16	350	140	210	30	35	105	5
200/75	S 20 20 07	* 360	180	180	90	60	90	1
200/110	S 20 20 11	* 360	180	180	70	60	70	1

d ₁ , d ₂	Code	L	l ₁ /l ₂	l ₃	k ₁	k ₂	k ₃	Qty
200/160	S 20 20 16	* 360	180	180	45	60	45	1
200/200	S 20 20 20	* 360	180	180	25	60	25	1
250/110	S 20 25 11	* 440	220	220	110	70	110	1
250/160	S 20 25 16	* 440	220	220	85	70	85	1
250/200	S 20 25 20	* 480	240	240	65	40	65	1
250/250	S 20 25 25	* 480	240	240	40	40	40	1
315/110	S 20 31 11	* 560	280	280	170	90	170	1
315/160	S 20 31 16	* 560	280	280	145	90	145	1
315/200	S 20 31 20	* 560	280	280	120	65	120	1
315/250	S 20 31 25	* 560	280	280	95	65	95	1
315/315	S 20 31 31	* 560	280	280	70	65	70	1

* Fabricated

Equal branches for rainwater applications only

Additional sizes are available.

For further information, contact our Customer Services department on **01622 852585**

DOUBLE BRANCH 45°

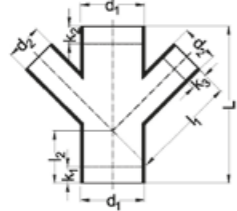

d ₁ /d ₂	Code	L	l ₁	l ₂	k ₁	k ₂	k ₃	Qty
110/110	S 36 11 11	270	180	100	65	20	20	10

DOUBLE BRANCH 60°

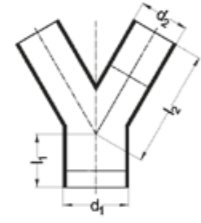

d ₁ /d ₂	Code	l ₁	l ₂	Qty
110/110	S 37 11 11	90	102	5

BRANCH 88.5° - SWEEP ENTRY

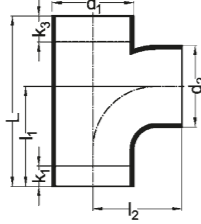

d ₁ /d ₂	Code	L	l ₁	l ₂	k ₁	k ₂	Qty
110/110	S 25 11 11	225	135	130	30	30	15

BRANCH 45° - CLEAN OUT

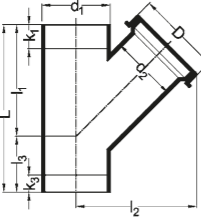

d ₁ /d ₂	Code	D	L	l ₁	l ₂	l ₃	k ₁	k ₂	Qty
110/110	S 33 11 00	140	270	180	195	90	20	55	1
160/110	S 33 16 00	140	375	250	220	125	45	45	1

BRANCH 90° - CLEAN OUT

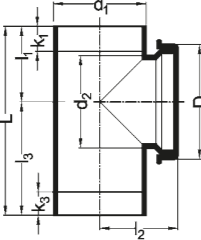

d ₁ /d ₂	Code	D	L	l ₁	l ₂	l ₃	k ₁	k ₂	Qty
56/56	S 23 56 00	83	175	70	100	105	30	65	1
75/75	S 23 07 00	91	175	70	100	105	25	55	1
110/110	S 23 11 20	127	225	90	105	135	20	65	1
160/110	S 23 16 20	140	350	140	140	210	60	135	1
200/110	S 23 20 00	140	360	180	160	180	90	90	1
250/110	S 23 25 00	140	440	220	185	220	110	110	1
315/110	S 23 31 00	140	560	280	220	280	170	170	1

BALL BRANCHES

d ₁ /d ₂	Code	Branch Configuration						L	l ₁	l ₂	D	k ₁	k ₂	Qty
		1 DOUBLE 90°	2 DOUBLE 135°	3 DOUBLE 180°	4 TRIPLE 90°	5 TRIPLE 135°	6 FOURFOLD 90°							
110/56	S 24 11 15	S 24 11 25	S 24 11 35	S 34 11 15	S 34 11 25	S 44 11 15	275	135	140	170	30	15	1	
110/75	S 24 11 17	S 24 11 27	S 24 11 37	S 34 11 17	S 34 11 27	S 44 11 17	275	135	140	170	30	15	1	
110/110	S 24 11 01	S 24 11 02	S 24 11 03	S 34 11 01	S 34 11 02	S 44 11 01	275	135	140	170	30	30	1	

GENERAL DIMENSIONS

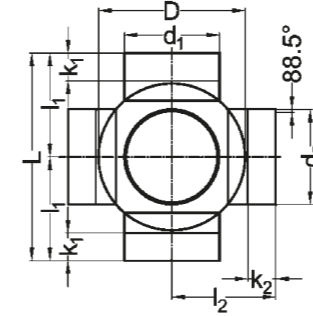

1 DOUBLE BALL BRANCH 88.5° FABRICATED - 90°

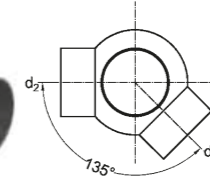

2 DOUBLE BALL BRANCH 88.5° FABRICATED - 135°

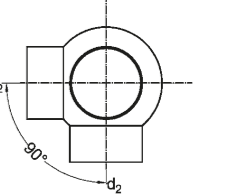

3 DOUBLE BALL BRANCH 88.5° FABRICATED - 180°

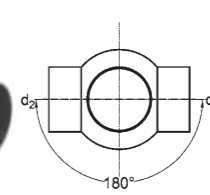

4 TRIPLE BALL BRANCH 88.5° FABRICATED - 90°

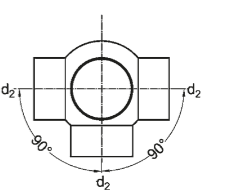

5 TRIPLE BALL BRANCH 88.5° FABRICATED - 135°

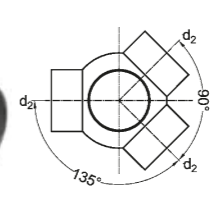

6 FOURFOLD BALL BRANCH 88.5° FABRICATED - 90°

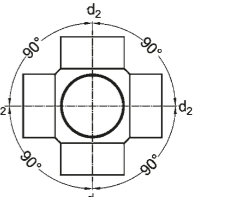

Additional sizes are available.

For further information, contact our Customer Services department on **01622 852585**

FOUR WAY RISER

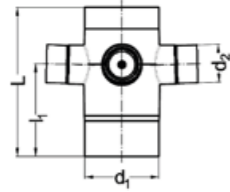

d ₁ /d ₂	Code	L	I ₁	Qty
110/56	S 46 11 11	232	144	1

4 x 56mm side inlets electrofusable (factory closed)
1 x 110mm top inlet electrofusable
1 x 110mm bottom outlet electrofusable

FOUR WAY SOIL MANIFOLD

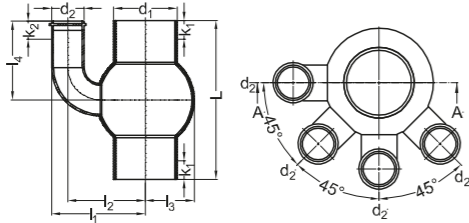

d ₁ /d ₂	Code	L	L ₁	L ₂	L ₃	L ₄	k ₁	k ₂	Qty
110/56	S 44 11 56	275	162	134	85	136	30	70	1

STACK-AERATOR

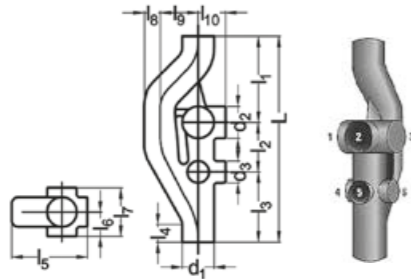

d ₁	Code	L	I ₁	I ₂	I ₃	I ₄	I ₅	I ₆	I ₇	I ₈	I ₉	Qty
110	S 60 11 17 *	705	295	170	240	60	279	89	178	55	130	1
160	S 60 16 17 *	750	330	170	250	60	339	114	228	80	140	1

* 1/2/3 = max. Ø 110 mm - 4/5/6 = max. Ø 75 mm
Butt-weld - hand-held hot plate recommended. See page 29 for further details.

END CAP - FLAT

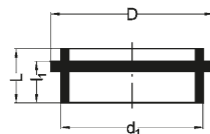

d ₁	Code	D	L	I ₁	Qty
56	S 67 56 07	64	16	12	20
75	S 67 07 07	85	21	16	20
110	S 67 11 07	120	19	19	20

Butt-weld only

END CAP - DOMED

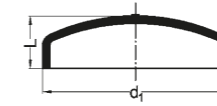

d ₁	Code	L	Qty
160	S 67 16 09	45	1
200	S 67 20 09	55	1
250	S 67 25 09	30	1
315	S 67 31 09	30	1

Butt-weld only

56MM BOSS ADAPTER

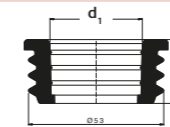

d ₁	Code	Qty
32	S 00 56 32	1
40	S 00 56 40	1

Material: TPE

REDUCER ECCENTRIC - LONG

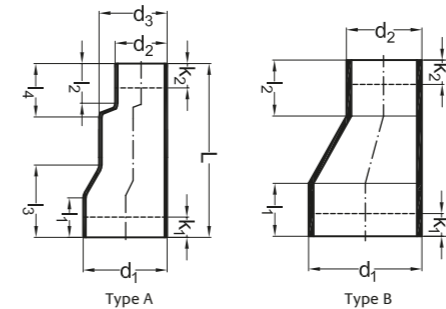

d ₁	Code	L	I ₁	I ₂	I ₃	I ₄	d ₃	k ₁	k ₂	Qty
200/110	S 14 20 11 *	335	95	36	165	55	160	75	20	1
200/160	S 14 20 16 **	260	95	95				75	75	1
250/200	S 14 25 20 **	290	105	95				85	75	1
315/200	S 14 31 20 *	580	115	95	235	190	250	95	75	1
315/250	S 14 31 25 **	340	115	105				75	85	1

* type A
** type B

REDUCER ECCENTRIC - SHORT

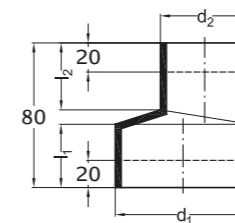

d ₁ /d ₂	Code	I ₁	I ₂	Qty
75/56	S 16 07 56	35	37	20
110/40	S 16 11 04	31	34	10
110/56	S 16 11 56	31	35	10
110/75	S 16 11 07	31	36	20
160/110	S 16 16 11	28	36	5

REDUCER CONCENTRIC

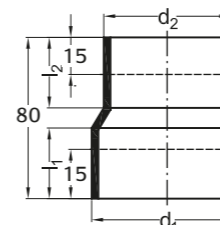

d ₁	Code	I ₁	I ₂	Qty
75/56	S 15 07 56	30	30	20
110/40	S 15 11 04	30	30	20
110/56	S 15 11 56	30	30	20
110/75	S 15 11 07	30	30	20
160/110	S 15 16 11	35	30	1
200/160	S 15 20 16 *	50	40	20
250/160	S 15 25 16 *	60	40	20
250/200	S 15 25 20 *	60	50	20
315/200	S 15 31 20 *	90	80	20
315/250	S 15 31 25 *	90	90	20

*Butt-weld only

Additional sizes are available.

For further information, contact our Customer Services department on **01622 852585**

CONTRACTION SLEEVE

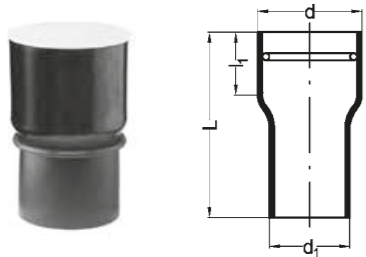

d ₁	Code	L	I ₁	d ₂	Qty
50/70	S 55 05 03	210	65	57-64	5
56/75	S 55 56 01	210	70	62-69	5
75/90	S 55 07 01	210	75	80-84	5
110/125	S 55 11 02	210	100	102-111	5

Seal: NBR
For jointing HDPE to concrete / clayware / copper / stainless steel

STUB FLANGE

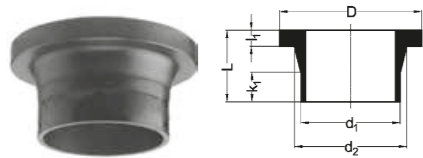

d ₁	Code	d ₂	D	L	I ₁	k ₁	Qty
56	S 47 56 02	* 70	102	60	14	15	5
75	S 47 07 02	* 89	120	50	16	15	5
110	S 47 11 02	125	158	80	18	30	5
160	S 47 16 02	175	210	80	18	30	1
200	S 47 20 02	* 232	268	100	18	40	1
250	S 47 25 02	* 285	320	100	20	40	1
315	S 47 31 02	* 335	370	100	20	40	1

* Butt-weld only

WC CONNECTOR 90°

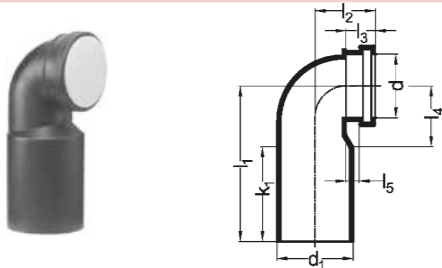

d ₁ /d	Code	I ₁	I ₂	I ₃	I ₄	I ₅	k ₁	Qty
110/90	S 50 11 85	* 225	76	34	95	17	120	10
110/110	S 50 11 82	** 225	75	30	92	19	120	10

* Seal: SBR
** Seal: NBR
Includes protection plug

WC CONNECTOR 90° – HORIZONTAL

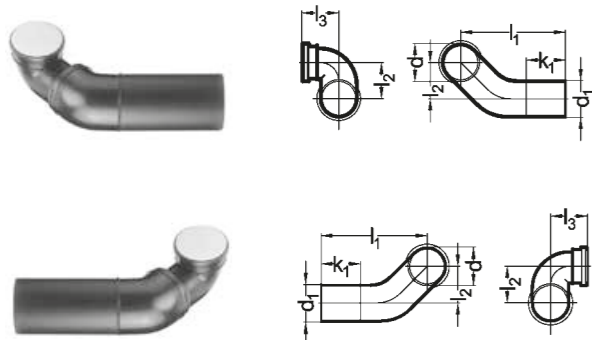

Left

d ₁ /d	Code	I ₁	I ₂	I ₃	k ₁	Qty
110/90	S 50 10 32	* 350	100	75	170	5
110/110	S 50 11 32	** 350	100	75	170	5

* Seal: SBR
** Seal: NBR
Includes protection plug

Right

d ₁ /d	Code	I ₁	I ₂	I ₃	k ₁	Qty
110/90	S 50 10 33	* 350	100	75	170	5
110/110	S 50 11 33	** 350	100	75	170	5

* Seal: SBR
** Seal: NBR
Includes protection plug

DOUBLE WC CONNECTOR 90° – VERTICAL

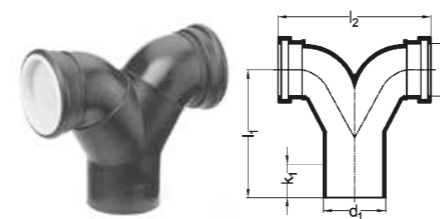

d ₁ /d	Code	I ₁	I ₂	k ₁	Qty
110/110	S 50 11 34	185	270	60	5

Seal: NBR
Includes protection plug

DOUBLE WC CONNECTOR 90° – HORIZONTAL

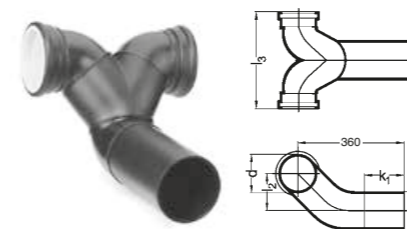

d ₁ /d	Code	I ₂	I ₃	k ₁	Qty
110/90	S 50 09 35	* 100	275	200	1
110/110	S 50 11 35	** 100	270	200	1

* Seal: EPDM
** Seal: NBR
Includes protection plug

WC CONNECTOR SOCKET

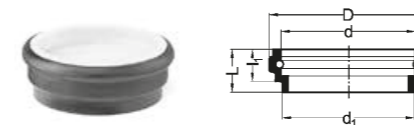

d ₁	Code	d	D	L	I ₁	Qty
90	S 50 09 51	* 90	113	49	38	10
110	S 50 11 71	** 110	130	45	28	10

* Seal: SBR
** Seal: NBR

HDPE pipe and fittings available in black, with the exception of protection plug (white)



Case study Crayford Town hall

The conversion of this very large masonry structure – originally built as part of the Vickers Armaments Factory in 1915. All of the plumbing and drainage work has been undertaken by specialist sub-contractor, Maybrick: including the installation of the Marley HDPE system, suspended beneath the soffit of the basement car park which extends across most of the building's footprint.

**Additional sizes
are available.**

For further information, contact our
Customer Services department on
01622 852585

BRACKET-ANCHOR

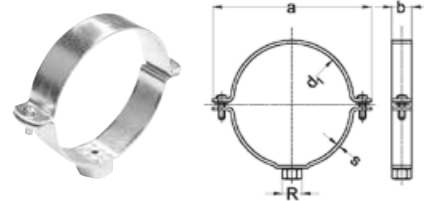

d ₁	Code	a	b	s	R	Qty
56	S 70 56 78	113	30	2.5	"½"	1
75	S 70 07 78	126	30	2.5	"½"	1
110	S 70 11 78	161	30	2.5	"½"	1
160	S 70 16 78	215	30	2.5	"½"	1
200	S 70 20 80	283	40	4	"1"	1
250	S 70 25 80	333	40	4	"1"	1
315	S 70 31 80	398	40	4	"1"	1

Galvanised steel

BRACKET-GUIDE

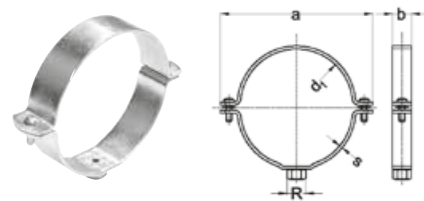

d ₁	Code	a	b	s	R	Qty
56	S 70 56 10	113	30	2.5	M10	1
75	S 70 07 10	126	30	2.5	M10	1
110	S 70 11 10	161	30	2.5	M10	1
160	S 70 16 10	215	30	2.5	M10	1

Galvanised steel

CLAMP LINERS

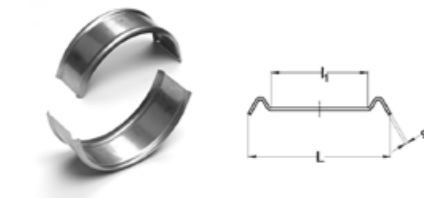

d ₁	Code	L	I ₁	S	Qty
56	S 70 56 15	40	30	1	1
75	S 70 07 15	40	30	1	1
110	S 70 11 15	40	30	1	1
160	S 70 16 15	40	30	1	1
200	S 70 20 15	50	38	1	1

MOUNTING PLATE

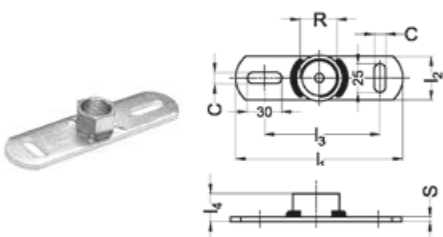

Code	R	I ₁	I ₂	I ₃	I ₄	S	C	Qty
S 70 94 78	*	½"	145	38	90	25	4 8,5	1
S 70 94 10	**	M10	145	38	90	14	4 8,5	1
S 70 94 80	**	1"	145	38	90	25	4 8,5	1

Galvanised steel

PIPE SCRAPER



Code	Qty
S 41 96 00	1

SPIDER SCRAPER



Code	Qty
S 41 98 65	1

With metal lever

SPIDER SCRAPER SPARE BLADES

Code	Qty
S 41 98 61	1

PIPE CUTTER



Size	Code	Qty
40-63mm	S 49 09 10	1
50-125mm	S 49 10 10	1
110-160mm	S 49 11 10	1

PE CLEANER



Code	Qty
S 60 10 00	1

GREASE PENCIL



Code	Qty
S 41 96 20	1

PROTECTION FOR PLUG-IN SOCKET



d ₁	Code	Qty
56	S 40 56 19	1
75	S 40 07 19	1
110	S 40 11 19	1
160	S 40 16 19	1
200	S 40 20 19	1

Fits on the inside of a plug in socket

PROTECTION CAP FOR PIPE END



d ₁	Code	D	L	Qty
56	S 40 56 29	58	35	1
75	S 40 07 29	78	35	1
110	S 40 11 29	113	40	1
160	S 40 16 29	164	40	1

HDPE Soil is a durable and tough drainage system, designed to be installed in accordance with EN12056 ‘Gravity drainage systems inside buildings’.

The excellent characteristics of high density polyethylene (HDPE) makes it suitable for a wide range of applications. HDPE is available in various pipe sizes, with a comprehensive range of fittings including connection fittings, sanitary fittings and tools.

The system has the following features:

- Complete system with excellent mechanical and chemical resistance properties
- Manufactured from polyethylene: a proven material that is tough, elastic and flexible
- HDPE pipe is tempered for reduced stress on connections
- Homogenous welded joints offer a completely closed system
- A wide range of mechanical joints for adjustability, flexibility and demounting
- Additives makes HDPE UV and weather resistant
- HDPE is highly suited for prefabrication
- Non-toxic plastic, 100% recyclable and environmentally friendly
- Stack-aerator is the perfect high-rise solution

Applications

HDPE is designed to be installed in accordance with EN 12056 and thereby meets the requirements for use in residential, commercial and public buildings.

HDPE is a non-pressure drainage system, not intended for pressure applications.

HDPE has a high temperature and chemical resistance which makes it ideal for drainage in:

- Student accommodation
- Apartments
- Commercial projects

It is flexible and tough for installation:

- Underground
- Embedded in concrete

Its closed system is perfect for applications where system integrity connections are critical like in:

- Industrial applications
- Ceiling voids and hard to reach places

Furthermore HDPE is a light weight system, highly suited for prefabrication. It allows you to meet the challenges of modern building design.

Application parameters

The pipes, fittings and seals can be used continuously at elevated temperature.

For a complete overview refer to the appendix on page 52. HDPE is suitable for the drainage of chemically aggressive waste water with a pH value of 2 (acidic) to 12 (basic) by default. For installations in applications not listed in this brochure or with chemicals not listed in the chemical resistance list of this brochure, please contact Technical Services on 01622 852695

Behaviour in fire corresponds to B2 normal combustibility according to DIN 4102. When a HDPE pipe system passes through fire-rated building elements, it is mandatory to install fire protection collars that will not reduce the fire-rating of these building elements.

Tempered Pipe

Marley HDPE pipe is tempered. This pipe is produced according to the standards EN 1519 and ISO 8770 and has undergone a heat treatment after extrusion. The result is less shrinkage when cooled down from high operational temperature. This gives less stress on joints resulting in a longer life for the pipe system.

The tempered pipes are suited for applications where the temperature of the pipe can get relatively high or vary considerably. Both can be caused by ambient temperature or temperature of the medium.

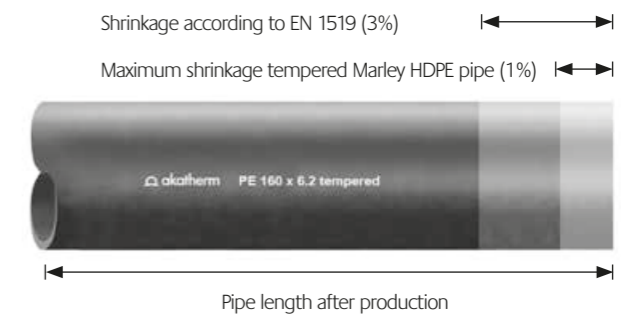

HDPE pipe has a standard length of 3m & 5m and is produced according to high quality standard with many international approvals.

Linear expansion

Marley HDPE material has a linear expansion coefficient of 0.18 mm/mK. We calculate with an expansion of 0.2mm per meter pipe for every °C temperature difference. The total length variation can be calculated as follows:

$$\Delta l = L \times \lambda \times \Delta t$$

Δl = length change in mm

L = total length of pipe

λ = linear expansion coefficient

Δt = temperature difference in °C

Example:

10 metres of pipe with a maximum temperature of 60°C and a minimum temperature of -20°C. This results in an expansion of:

$$\Delta l = 10 \times 0,2 \times 80 = 160 \text{ mm}$$

Length changes can be accommodated by the expansion socket which can take up the expansion and contraction of a 5 meter length of pipe for temperatures between -20°C and 70°C.

Abbreviations

Abbreviation	
D	External dimension fitting part
d1, d2 ...	External dimension fitting/pipe
e	Wall thickness
k1, k2 ...	Maximum length for shortening fittings
L	Total length fitting
l1, l2 ...	Lengths of part of fitting
TPE	Thermoplastic Elastomer
SBR	Styrol butadiene rubber
NBR	Acrylnitril-butadiene rubber
HDPE	High density polyethylene
SDR	Ratio diameter / wall thickness d1/e

Fittings

HDPE fittings are high quality injection moulded products produced under ISO9001 quality management. Prefabricated product exceptions are clearly listed in the product tables. Marley offers a complete wide range of fittings including:

- Reducers
- Bends
- Elbows
- Branches
- End caps
- Electrofusion couplers
- Sanitary fittings

Fixing materials for wall and ceiling construction are also available.

All HDPE fittings are electrofusible, unless stated

In some situations, it is necessary to shorten fittings. Fittings with the dimension “k” included in the product table can be maximally shortened by the “k” dimension in order to still allow butt-welding using a standard butt-welding machine. The k-dimension of the relevant spigot of most fittings is listed in the product tables.

The fittings are dimensionally standardised to improve prefabrication repetition work and to facilitate welding alignment. Each fitting contains a graduated arc at 15° intervals.

Tools

Marley offer a range of tools to be used for installation of HDPE:

- Pipe cutters
- Pipe and fitting scrapers
- PE cleaner and marking pencils

Refer to page 17 for further details.

HDPE properties

Polyethylene (PE), is a semi crystalline thermoplastic and is a generic term for different kinds of PE. By colouring with 2% of 'carbon black' the PE gets its black colour. The following kinds of PE are generally used:

- LDPE (Density 0.90-0.91 g/cm³)
- MDPE (Density 0.93-0.94 g/cm³)
- HDPE (Density 0.94-0.97 g/cm³)

In pipe systems generally only HDPE is used. HDPE has a high resistance against acids, bases and aqueous salt-solutions. Below 60°C it is practically unsolvable in organic solutions. HDPE has a good resistance against light ionised radiation without becoming radioactive itself.

Technical specifications

	Unit	Test method	Value
Density at 23°C	g/cm ³	ISO 1183	0.954
Elasticity modulus	N/mm ²	ISO 527	850
Bending creep modulus	N/mm ²	DIN 54852-Z4	1000
Tensile strength at 23°C	N/mm ²	ISO 527	22
Elongation at break	%	ISO R 527	300
Linear expansion coefficient	mm/mK	DIN 53752	0.18
Indentation hardness	N/mm ²	ISO 2039	36 - 46
Ignition temperature	°C	-	~350
Thermal conductivity	W/m . K	DIN 52612	0.37 - 0.43
Shore hardness		ISO 868	61
Crystallite melting range	°C		125 - 131
Operational temperature range	°C	-	-40 - +80*
Melt Flow Rate MFR 190/5	g/10 min	ISO 1133	0.43

* up to 100°C for short periods of time.

Ecological properties of HDPE

Polyethylene consists of only carbon and hydrogen atoms. These substances are not harmful to humans, animals and plants. Marley uses High Density Polyethylene classified with recycle mark 3.



Polyethylene is made from oil and electricity without chemical additives released during production. It is not broken down by bacteria very fast and has a long lifetime. The total energy consumption during production and transport is very low compared to steel, copper or cast iron.

Because PE is a thermoplastic polymer it can be melted at the end of its technical lifetime and used for other applications. When PE is burnt, only non-toxic carbon dioxide and water is released.

Chemical resistance

When transporting chemical waste waters the following factors have to be taken into account:

- The medium
- The concentration of this medium
- Temperature
- Duration of exposure
- Volume

Refer to appendix A for a complete chemical resistance table of Marley HDPE on page 52.

Trace heating

Animal and vegetable-based oil and grease discharged by commercial kitchens are separated from the waste water by grease separators. HDPE is very well suited to connect the discharge fixtures to the grease separator. When the pipe system has enough length, the grease can accumulate and lead to serious blockage of the pipe system. The use of trace heating and additional insulation may be required to reduce heat loss. The trace heating element should not exceed 45°C.

Embedding HDPE in concrete

The HDPE system is suited to be embedded in concrete. Before pouring the concrete all welds need to be cooled down and it is preferable to check the pipe system for leakage. To prevent the pipes from floating upwards the systems needs to be properly bracketed to keep it in place.

Quick drying concrete

Quick drying concrete will undergo an exothermic reaction which releases heat during its process. The heat will soften the HDPE pipe and influence the maximum allowed pressure. Adequate protection must be provided to the HDPE system like filling the system with water. For further information on embedding HDPE in concrete see page 43.

Pressure and heat during concrete pouring

When a pipe system is vertically installed into concrete the liquid concrete will cause outer pressure, possibly exceeding the maximum ring stiffness depending on the height of the installation.

To increase the maximum installation height the pipe can be filled with water (and closed) to compensate for the outer pressure. Refer to the table opposite for the maximum allowed height depending also on the wall thickness of the pipes and fittings (at 30°C).

Diameter (mm)	Wall thickness (mm)	Allowed height (m)	
		Empty	Filled with water
40	3.0	26.0	45.0
50	3.0	14.0	24.0
56	3.0	7.0	12.0
63	3.0	7.0	12.0
75	3.0	3.8	6.5
90	3.5	3.8	6.5
110	4.2	3.8	6.5
125	4.8	3.8	6.5
160	6.2	3.8	6.5
200	6.2	2.0	3.5
250	7.7	2.0	3.5
315	9.7	2.0	3.5
200	7.7	3.8	6.5
250	9.6	3.8	6.5
315	12.1	3.8	6.5

Thermal movement of HDPE

A physical principal is that all materials expand as the temperature increases. If the temperature drops, the material contracts. Each material has its own unique coefficient of expansion (α).

For HDPE : α = 0,18 mm/m • K
The formula for length change is:

$$\Delta L = L \times \alpha \times \Delta T$$

ΔL = length change of pipe system [mm]
L = total pipe length [m]
ΔT = difference with installation temperature [°C]
α = 0,18 mm/m • °K

$$\Delta T 50^\circ = 10 \text{ mm/m}$$

In residential applications the maximum wall temperature difference of the connector and collector pipes is 40°C, even during short periods of 80°C to 90°C temperature water discharge.

When installed at 30° a Marley HDPE pipe of 5m long will behave as follows:

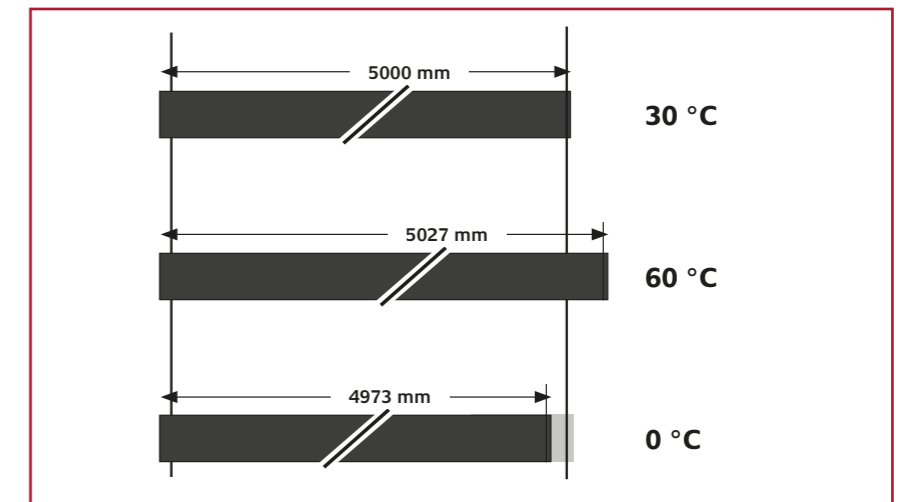

For downpipes and ground pipes the maximum wall temperature difference is 20°C.

In general for a long-lasting discharge of high volume hot water the maximum wall temperature difference is 60°C.

Please note that this is the temperature difference over the complete circumference of the pipe, the variation in the discharge temperature can be a lot higher.

Installation

Installation underground

Due to specific properties such as flexibility and resistance to cold temperature (freezing), HDPE pipe systems are ideal for use in underground pipe lines. Buried pipes are exposed to various loads. The stability of HDPE makes it possible to bury the pipes at substantial depth. The suitability depends on such factors as depth, groundwater level, density of the soil and traffic load. For further information on installing HDPE underground see page 44.

Soil and traffic loads

The load capacity of underground plastic pipes is based on changes in the pipe and movement of the ground. The soil load causes the top of the pipe to deflect downward. The sides of pipe are correspondingly pressed outward against the surrounding soil. The reaction pressure, the lateral force exercised on the pipe, prevents a larger cross-sectional deformation (support function). The construction of the trench, the type of bedding used and the backfilling of the trench are, to a large extent, decisive factors determining the load capacity of an underground plastic pipe. The load needs to be evenly distributed over the entire pipe line. For this reason, the trench must be created in such a manner that bends in a longitudinal direction and loads at specific points are avoided. It is assumed that the increased pressure resulting from traffic loads caused by road or rail traffic are surface evenly distributed over the pipe sectional plane.

Groundwater

Underground pipes can be subject to external overpressure, especially in areas with high groundwater levels. In addition, a pipe enclosed in concrete is exposed to external pressure, though just for a short period. Underground pipe systems subject to additional external pressure must be tested for the ability to withstand denting. The effective load due to external pressure will agree with the related hydrostatic pressure on the pipe axis.

For special circumstances contact our Technical Service department on 01622 852695.



Case study Dollar Bay, London

Marley provided a tailor-made plumbing solution for the Dollar Bay apartments, a 32-storey build in the heart of Canary Wharf. The build has seen a range of Marley's products installed throughout, including HDPE fabricated soil systems.

"Marley's technical team created specialised branches for us to install in the bathrooms of the apartment to level-up to toilet and basins. Their expertise in this area is second-to-none. Using the Marley Fabrications service saved us time on site and we wouldn't hesitate to use it again."

Paul Oliva, Contracts Manager at Bowmite Electrical & Mechanical, sub-contractors on the project.

HDPE jointing methods



HDPE fittings and pipes can be joined by different methods. Joints are divided in welded/mechanical and pull-tight/not pull-tight. Pull-tight joints can't come apart under influence of external forces.

To be opened (demountable)

These are jointing methods which can be disconnected after assembly. These jointing methods are ideal for pipe sections which need to be cleaned, calibrated, inspected or dismantled on a regular basis.

Not to be opened (fixed)

These are jointing methods which cannot be disconnected after assembly. These are permanent joints in which the joints can remain closed for their lifetime.

Tension-resistant (pull tight: PT)

These are connections which withstand tensional forces. This is ideal when thermal movement is expected or gravity pulls on the connection.

Non-tension-resistant (not pull tight: NPT)

These are connections which cannot withstand tensional forces. This joint is used when the pipe system is designed to accommodate movement without risk that the joint is pulled apart.

Jointing technique	Product	Welded/mechanical	Pull-tight	Demountable
Electrofusion		Welded	Yes	No
Butt-weld joint		Welded	Yes	No
Plug-in Socket		Mechanical	No	Yes
Expansion Socket		Mechanical	No	Yes
Snap Socket *		Mechanical	Yes	No
Screw Coupler *		Mechanical	Yes	Yes
Flanges *		Mechanical	Yes	Yes
Contraction Joint *		Mechanical	No	No

* Available on request

Electrofusion

Electrofusion is a rapid and simple way of permanent jointing. Using the electrofusion couplers and equipment, pipes, fittings and prefabricated pipe sections can efficiently be assembled. All HDPE products can be welded by electrofusion unless specifically stated in the product table, see pages 6-17.



Electrofusion couplers

Couplers are extremely suitable for applications in wastewater and rainwater drainage, with the following features:

1. Injection moulded with excellent dimensional accuracy and stability.
2. Welding indicators on each welding surface for visual identification to show that the coupler has been welded.
3. Centre stops are easy to remove, in order to use the coupler as a slip coupler.
4. Resistance wires fixed to the surface for an optimal heat transfer and therefore a high quality welding connection.
5. Yellow edge surrounding the welding indicators of the diameters 200, 250 and 315mm are provided for better visibility.

The resistance wires are positioned in the fusion zone. On both sides of a fusion zone, a cold zone prevents the molten HDPE from outpouring thereby containing the fusion process.

During the fusion process the pipe/fitting expands and touches the inner coupler wall. The electrofusion joint is made with the pressure caused by the expanding HDPE and the heat from the resistance wires.

Electrofusion coupler with fusion and cold zones



Without removing the oxygen layer a weld cannot be guaranteed.

Preparations

The following guidelines are of importance when making an accurate electrofusion joint:

- Establish a work space where the welding can be done without being effected by major weather conditions. Temperature $-10^{\circ}\text{C}/+40^{\circ}\text{C}$.
- Check if the equipment functions properly. Welding equipment used on site deserves special attention.
- The resistance wire in the electrofusion coupler lies at the surface for a good heat exchange. The resistance wires need to be covered by the inserted pipe or fitting to ensure correct operation.
- Complete insertion is essential to utilise the fusion and cold zones in the coupler.
- Make sure both ends inserted into the coupler have been properly scraped and have been cleaned. Both pipes and fittings need removal of the oxidation layer.

Welding process

After connecting the cables of the control box the welding process can commence by pushing the start button. The control box adapts the welding time to the ambient temperature. When it is colder than 20°C the welding time is extended and when the ambient temperature exceeds 20°C the welding time is shortened. For welding times and cooling down times see table below.

dimension d_1 mm	system	weld time sec	cooling time min
40-160	Constant current 5A	80	20
200-315	Constant voltage 220V	420	30

The joint assembly should not be disturbed during the fusion cycle and for the specified cooling time afterwards. A full load can only be applied after the complete cooling time. The cooling period can be reduced by 50% when there is no additional load or strain during cooling.



Compared to a butt-weld, it is harder to judge a good electrofusion weld. The welding indicators on the electrofusion coupler provide an indication if the weld has actually been executed. However, they do not guarantee the integrity of the joint. The amount of movement of the pop-out depends on several factors including the size tolerances of the components and any ovality of the pipe or fitting.

A joint can be marked o.k. when the welding preparations such as marking insertion depth, scraping making sure that there was no additional load during welding and cooling have been executed successfully. If a significant quantity of melt flows out from the fitting after welding, there may be a misalignment of the components, the tolerances may be excessive or a second welding may have

accidentally occurred. The integrity of such a joint is suspicious.

Please note that the fitting will become too hot to be touched during the welding process. The temperature will continue to increase for some time after the fusion process has been completed.

Deformation

A big deformation of pipe and fitting can cause problems during assembly and welding of the components. The maximum allowed deformation of pipe or fitting spigot is $0.02 \times d_1$. This results in a maximum difference between the largest and smallest diameter corresponding with the table below. The pipe or fitting spigot needs to be "rounded" using clamps when the deformation is larger.

diameter d_1	$d_1 \text{ max} - d_1 \text{ min}$ (mm)
40	1.0
50	1.0
56	1.0
63	1.0
75	1.5
90	2.0
110	2.0
125	2.5
160	3.0
200	4.0
250	5.0
315	6.0

Correct Jointing procedure

1. Cut the pipe square

The pipe ends must be cut square to ensure that the heating element in the coupler is completely covered by the pipe or fitting.



2. Mark insertion depth + 10 mm

This is to ensure that across the full welding zone the oxidised layer will be removed.



3. Scrape pipe and mark insertion depth again

The outer surface of the pipe (approx. 0.2mm deep) must be scraped for the full distance that will be covered by the coupler to remove any surface 'oxidation'.

The insertion depth should be marked again to safeguard full insertion.

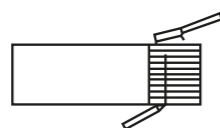

4. Clean coupler

Before assembling the pipes into the coupler ensure that all surfaces are clean and dry.



5. Insert pipe and/or fitting up to pipe stop

Ensure that the pipe is pushed as straight as possible into the fitting.

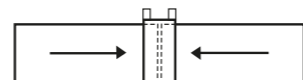

Incorrect Jointing procedure

1. Misalignment

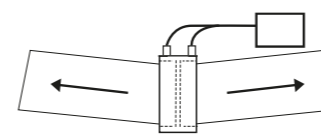

2. Coupler sliding when installed vertical

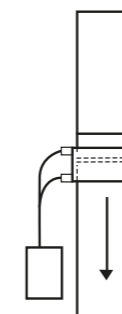

3. Welding more than once

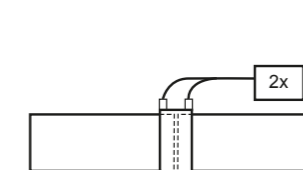

4. Load on vertical pipe

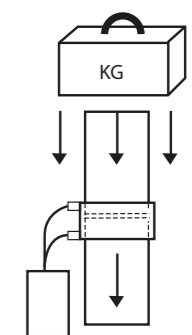

Butt-weld

Butt-welding is a very economical and reliable jointing technique for making welded joints, requiring only butt-welding equipment. All pipes and fittings can be joined by this welding method. Fittings for which a k-dimension is shown in the product section, (pages 6-17), can be shortened by no more than this amount. Butt-welding is extremely suitable for prefabricating pipe sections and for making special fittings.



Preparations

The following guidelines are of importance when making an accurate butt-weld:

- Establish a work space where the jointing can be done without being effected by major weather conditions.
- Check the equipment functions properly. Welding equipment used on site deserves special attention.
- The fittings and or pipes need to be aligned in the welding machine. Mis-alignment can be up to 10% of the wall thickness.
- Clean the heating element before each jointing operation with a lint-free cloth and suitable cleaner (see instructions supplied with the welding machine).
- Cut the pipe and/or fitting with a pipe cutter to make the end square.
- Make sure that once the pipe and/or fitting ends have been machined, they do not get dirty. Do not touch them with your hands. The surface needs to be clear of oil, grease and dirt.

- Put the pipe parts into the welding machine to facilitate a firm hold during the jointing process.
- A digital thermometer can be used to check the temperature of the heating plate. The temperature should be checked at several points around the plate and should be between 200°C and 220°C. Maximum deviation between points is given in the table.



Maximum temperature variation heating element

Used surface of heating element for welding diameter (d ₁)	Δ ¹ max
d ₁ = 40-160	8°C
d ₁ = 200-315	10°C

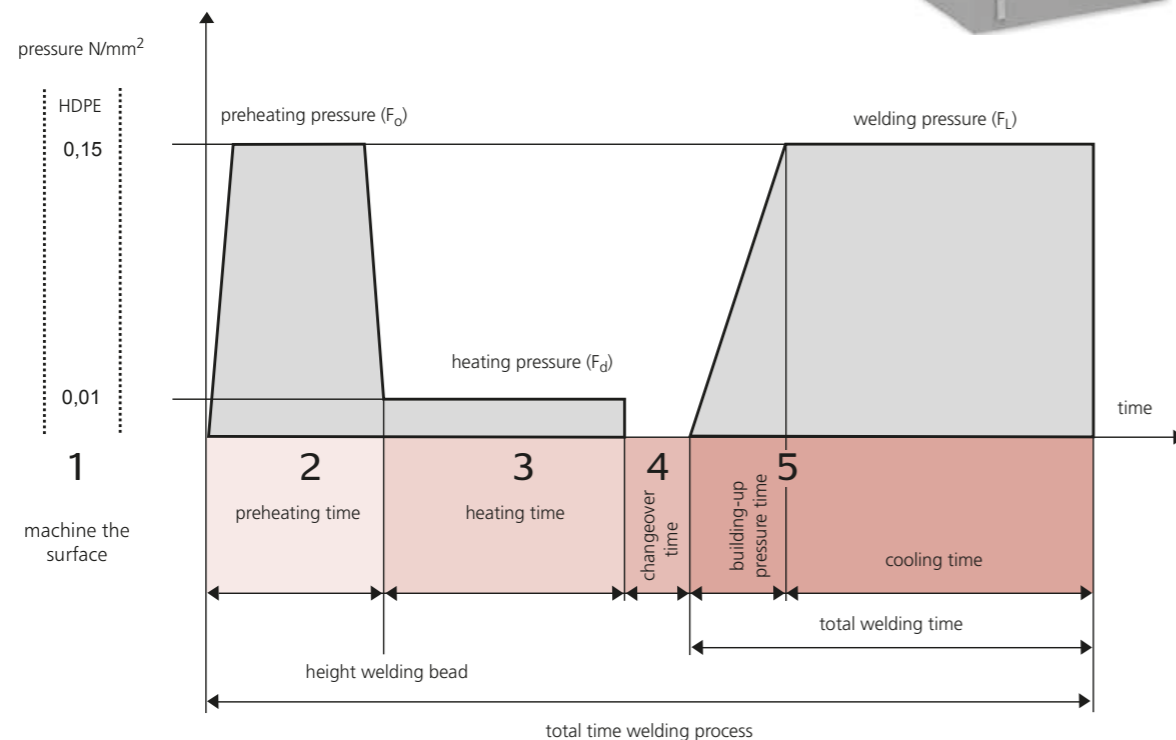

Butt-weld process

The butt-welding of Marley HDPE operates according to the following steps: (The five steps below relate to the image on page 26).

1. Machining the surface

Both sides should be machined until they run parallel. When the machining is finished, open the carriages (the plastic shavings must be continuous and uniform in both sides to weld). Take off the milling cutter.

Verify the alignment between the machined surfaces. Remove the plastic shaving. Do not touch or get any dirt on the machined surfaces.

Without removing the oxygen layer a weld cannot be guaranteed.

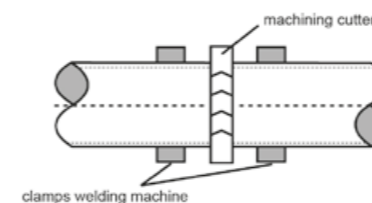

2. Preheating under pressure

Press the two ends to be jointed gradually on to the heating element until a bead is created. The size of the bead is a good indication that the appropriate pressure and time is used. For pressure and bead size see the table on page 28.

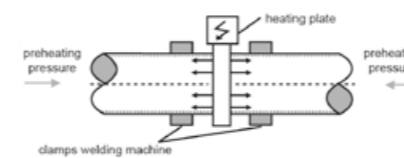

3. Heating up with less pressure

HDPE is a good insulator, therefore at this stage it is necessary that the correct heating depth of the pipe ends is obtained. Only a small amount of pressure 0.01 N/mm² is required to maintain the contact of the pipe ends with the heating element. The heat will gradually spread through the pipe/fitting end. The size of the bead will increase a little. The time and pressure needed for this phase can be found in the table on page 28.

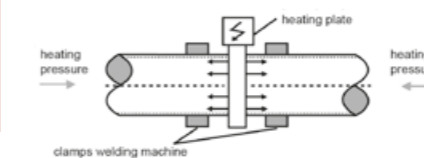

4. Change over

Remove the heating element from the jointing areas and immediately make those areas touch each other. Do not push the pipe ends abruptly onto each other.

The removal of the heating element needs to be done quickly to prevent the pipe ends from cooling down. The times for changing over can be found in the table on page 28.

5. Welding and cooling

After the jointing areas have made contact they should be joined with a gradual increase in pressure up to the specified value. Keep the specified welding pressure at a constant level during the cooling period. Do not cool artificially.

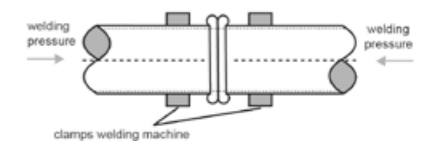

The welded components can be removed from the machine when 50% of the cooling period has elapsed, providing that this is done carefully, with no load or strain being placed on the joint. The joint must then be left undisturbed for the remainder of the cooling period.

HDPE Welding parameters

In this table the welding parameters can be found for Marley HDPE. The exact regulation of the welding machine depends on its mechanical resistance. The tables provided with the machine are to be used for regulating the machine.

Diameter d_1 mm	Wall thickness e mm	Preheating pressure / welding pressure (0,15 N/mm ²) F_0/F_L N	Heating pressure (0,01 N/mm ²) F_d N	Height welding bead mm	Heating time sec	Changeover time sec	Building-up pressure time sec	Cooling time min
*40	3.0	55	4	0.5	29	4	4	4
*50	3.0	70	5	0.5	30	4	4	4
56	3.0	75	5	0.5	30	4	4	4
*63	3.0	85	6	0.5	31	4	4	4
75	3.0	105	7	0.5	32	5	5	4
*90	3.5	145	10	0.5	35	5	5	4
110	4.2	210	14	0.5	42	5	5	6
*125	4.8	275	18	1.0	48	5	5	6
*125	3.9	225	15	0.5	39	5	5	5
160	6.2	450	30	1.0	62	6	6	9
110	3.4	175	12	0.5	35	5	5	4
160	4.9	370	25	1.0	49	5	5	7
200	6.2	570	38	1.0	62	6	6	9
250	7.8	900	60	1.5	77	6	6	11
315	9.7	1400	93	1.5	77	6	6	11
200	7.7	700	47	1.5	77	6	6	11
250	9.6	1090	73	1.5	97	7	7	13
315	12.1	1730	115	2.0	121	6	8	16

*Please note these sizes are made to order and require a 28 day lead time.



Installation videos

For further details on how to butt-weld or electrofusion joint the HDPE System go to the video section at marleypd.co.uk

Evaluating the butt-weld

The butt-weld can be evaluated using destructive and non destructive evaluation methods. For these evaluations special equipment has to be used. Butt-welds can easily be judged by a visual inspection making this the recommended method for a first evaluation.

The shape of the welding bead is an indication for the proper operation of the welding process. Both welding beads should have the same shape and size. The width of the welding bead should be approximately 0.5 x the height.

Differences between the beads can be caused by the difference in HDPE material used in the welded components. Despite the differences in welding bead the butt can be of sufficient strength.

Butt-weld with even welding beads (acceptable)

In the next illustration a good weld is shown with a uniform welding bead. At a visual inspection this would be classified as an "acceptable" weld.

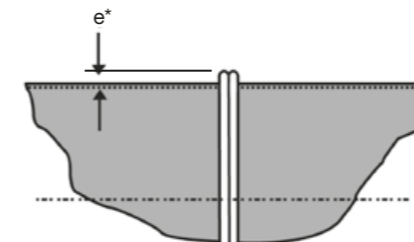

Butt-weld with mis-alignment of pipe (acceptable)

Mis-alignment between fittings and pipe can occur for several reasons. Oval pipe ends or irregular necking of the pipe can cause an incomplete fit. If this is less than 10% of the wall thickness the weld can still be classified as "acceptable".

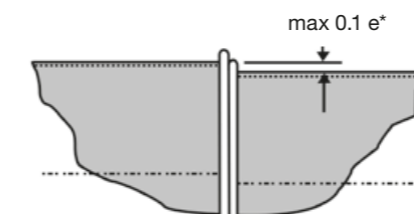

Butt-weld with big welding beads (acceptable)

The next illustration shows a joint with beads that are too big. The uniformity indicates a good joint preparation. Heat supply and jointing pressure settings, however, are too high. A purely visual assessment would still classify the weld as "acceptable".

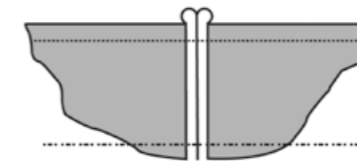

Butt-weld (not acceptable)

When there is either insufficient heating up or too low welding pressure there are hardly any beads. In cases like this thick walled pipes often form shrinking cavities. The weld must be classified as "not acceptable".

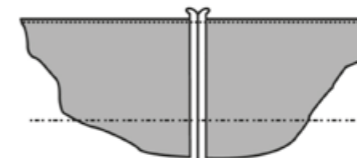

Cross section of a good butt-weld (acceptable)

In the next illustration a cross-section of a regular, round fusion bead, free of notches or sagging is shown. Special attention should be paid to the fact that the collar value 'K' is greater than 0.

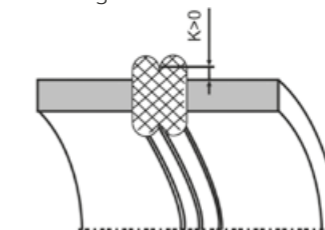

* For the value of 'e' please refer to the table on the previous page

Welding by hand

In general butt-welds are made using a butt-welding machine. However up to the diameter $d_1 = 75\text{mm}$ the weld can be made by hand. At 90mm and above the welding pressures are too big to make a good weld by hand. The welding process is identical to butt-welding with a machine:

1. Preheating

Push the pipe/fittings against the heating plate until the required welding bead has been formed (see table on the previous page for further details).

2. Heating up

Hold the pipe/fittings against the heating plate with no pressure (for time see table on the previous page).

3. Change over/welding/cooling

As the spigots are thoroughly heated up, both parts need to be joined as quickly as possible using a gentle buildup of pressure. The jointing has to be carried out accurately because moving the parts during and after jointing is not possible.

Keep the parts jointed together under pressure as long as the welding bead is still plasticized (this can be checked by pressing your fingernail into the bead). The joint then needs to cool down without any additional load. The use of a support structure is recommended when jointing long pipe parts. Using a butt-welding machine gives a better result under all circumstances.

HDPE jointing methods

A: Plug-in joint socket

A plug-in joint is an easy to make, detachable and non pull-tight jointing method.



B: Expansion joint socket

Expansion sockets can absorb length changes of pipes with a maximum length of 5m.



Jointing process:

1. Cut pipe square and remove burr

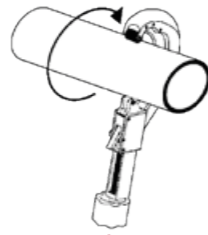

2. A Mark insertion depth

The pipe needs to be inserted in the plug in socket using the full insertion depth.

A plug-in joint is not to be used to accommodate the expansion and contraction of a pipe system.

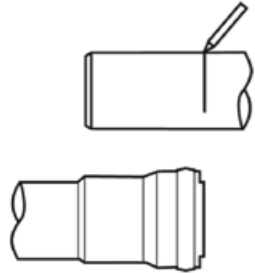

2. B Mark insertion depth

An expansion socket counteracts the variation in length caused by the thermal expansion and shrinkage of the pipe.

Depending on the ambient temperature the insertion depth varies. The right insertion depth for both 0°C and 20°C is indicated on the expansion socket.

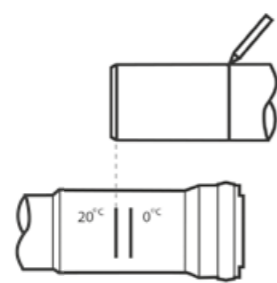

3. Chamfer pipe end

The pipe-end needs to be chamfered at an angle of 15°. To obtain an even cut a chamfering tool should be used.

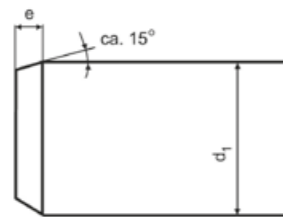

4. Make joint

Lubricate the pipe end and insert the pipe up to the marked insertion depth.

HDPE Expansion Details

Diameter	Total Length	Min. Insertion Depth @ 20°C	Max. Expansion	Type A	Type B
				(No white retaining ring)	(With white retaining ring)
*40mm	132mm	76mm	56mm		Type B
*50mm	132mm	76mm	56mm		Type B
56mm	132mm	76mm	56mm		Type B
*63mm	132mm	76mm	56mm		Type B
75mm	-	On Fitting	On Fitting	Type A	
*90mm	-	On Fitting	On Fitting	Type A	
110mm	-	On Fitting	On Fitting	Type A	
*125mm	-	On Fitting	On Fitting	Type A	
160mm	-	On Fitting	On Fitting	Type A	
200mm	230mm	120mm	110mm	Type A	
250mm	250mm	125mm	125mm	Type A	
315mm	270mm	126mm	144mm	Type A	

*Please note these sizes are made to order and require a 28 day lead time.

THE EXPERTS IN FABRICATED DRAINAGE

Save time on site by utilising the skills at Marley to build your bespoke fabricated soil system in the material of your choice



SAVES MONEY



EXPERTISE



SAVES STORAGE



SIMPLIFICATION



SAVES TIME



QUALITY, ASSURED



SAVES WASTE



DELIVERY WHEN YOU NEED IT



Transitions to other materials

Transition to PVC and dBlue systems

Transitions to metric PVC and dBlue systems can be made using a rubber ring joint or by screw couplers.

Refer to the table on the right for the type of fittings, the dimensions and product code.

The Marley HDPE range can be connected to PVC-c or ABS materials, allowing for easy waste pipe connection to the discharge stack.

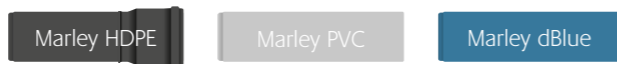

Fitting type	Diameter range (mm)	Code
Plug-in socket	40-160	S 42 xx 50
Snap socket	40-200	S 40 xx 10
Expansion socket	40-315	S 4x xx 20
Screw coupler	40-110	S 43 xx 30

Bottle traps:

32mm and 40mm plug-in socket to bottle traps.

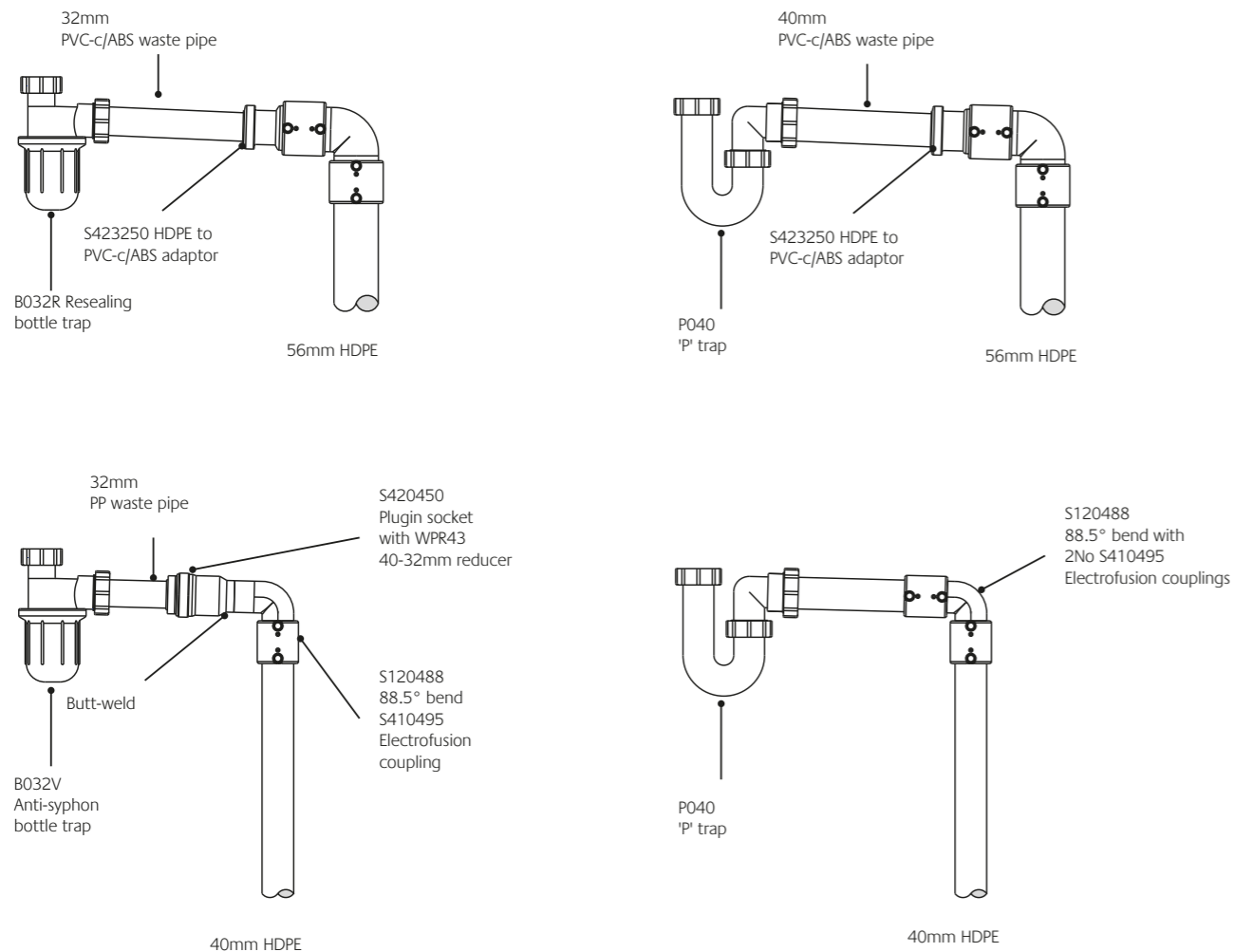

Alternative connectors:

HDPE to PVC-u and PVC-c.

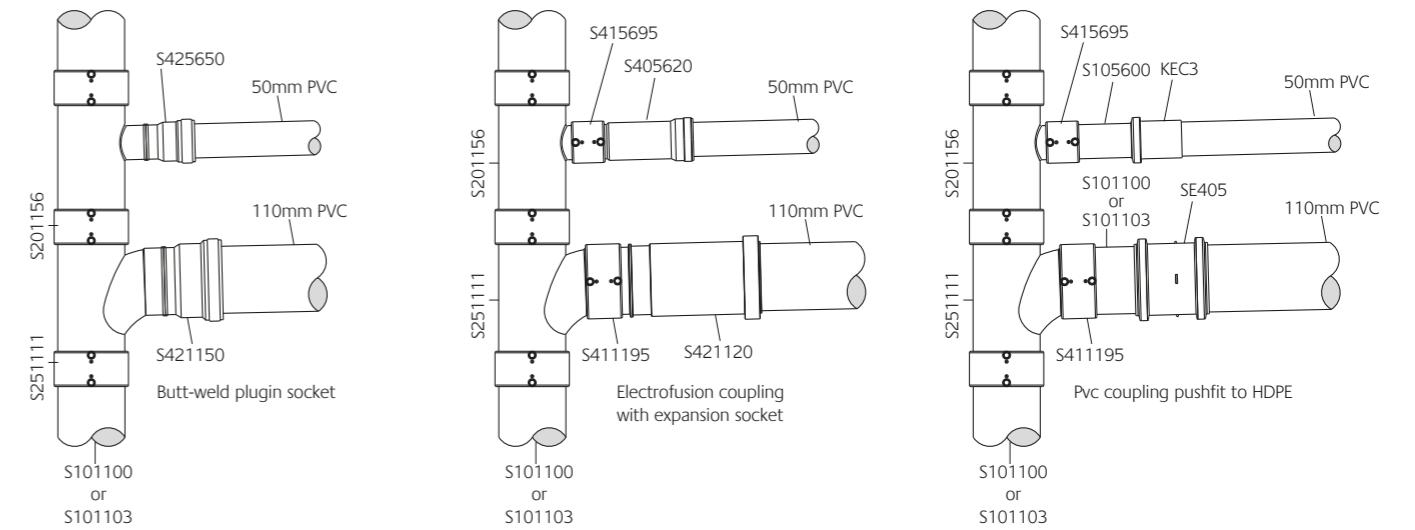

Bends at the base of stacks

Bends at the base of vertical stacks should be of long radius and have a minimum centre line of 200mm on a 100mm nominal size stack. Two 45° bends may also be used as an alternative to provide the change of direction. The same design principle should also be adopted where offsets occur in stacks that have more than one storey height above the offset.

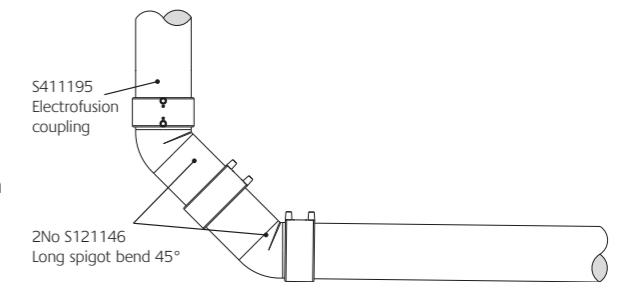

Connection to AAV

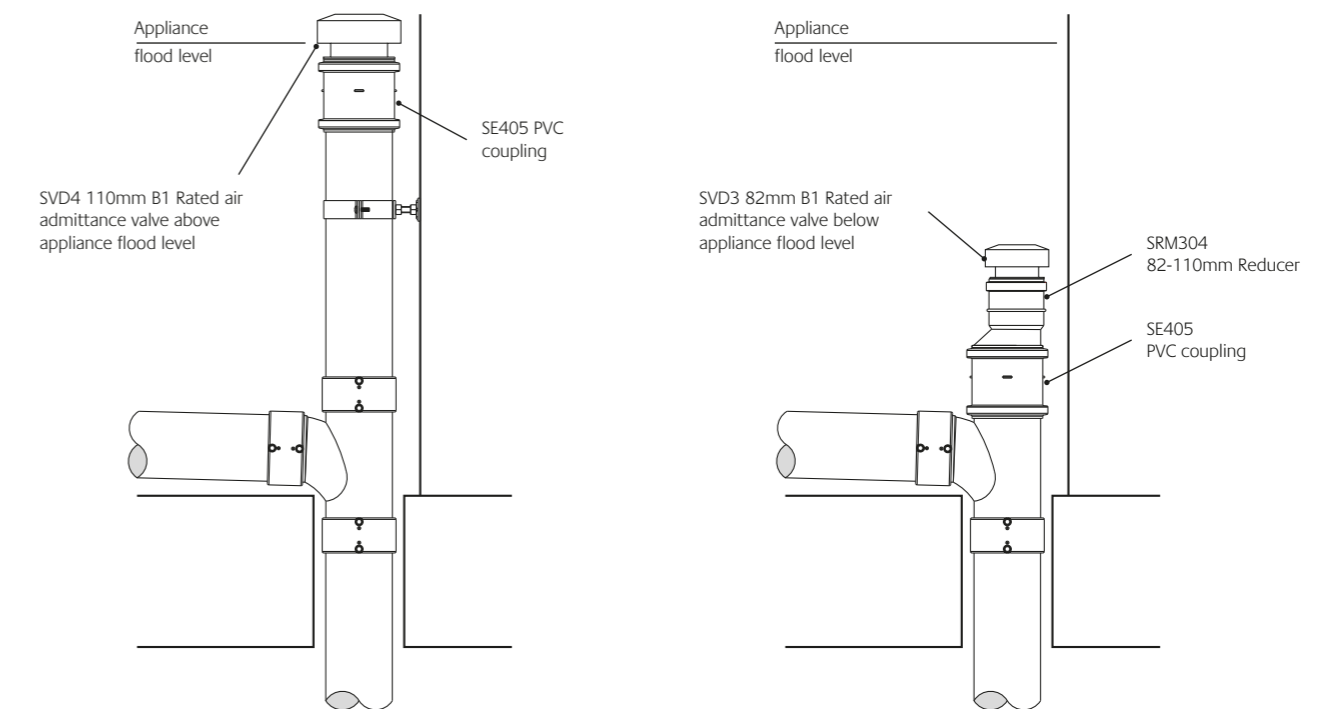

Transitions to other materials

Transition to metal thread

The transition from HDPE to metal thread requires screw thread adaptors available to order.

The adaptors are available with inside and outside thread in HDPE connection diameters 40, 50 and 63 mm. The adaptors have a cylindrical thread dimensioned according to DIN-ISO 288-1 with threads in 1/2", 3/4", 1", 1 1/4", 1 1/2", 2".

Speak to our Technical Services Department on 01622 852695 for a complete overview of product codes and available combinations.

Transition to cast iron

The transition from HDPE to cast iron requires special transition fittings to allow the change in outer diameter.



Available from Marley are transitions to cast iron in HDPE dimensions 200, 250 and 315 mm. Refer to the table below for the dimensions and product codes.

HDPE (mm)	Cast iron (mm)	Code
200	222	S 56 20 50
250	274	S 56 25 50
315	326	S 56 31 50

Transition to stoneware

The transition from HDPE to stoneware requires special transition fittings to allow the change in outer diameter.



Available from Marley are transitions to stoneware in HDPE dimensions 110 to 315 mm. Refer to the table below for the dimensions and product codes.

HDPE (mm)	Stoneware (mm)	Code
110	131	S 56 11 40
125	159	S 56 12 40
160	186	S 56 16 40
200	242	S 56 20 40
250	299	S 56 25 40
315	355	S 56 31 40

Transition to plumbing fixture fittings

Connections to plumbing are typically made to other materials, such as PVC, ABS, PP. Marley's HDPE adaptors can be seen on page 6. Marley also offer a range of traps and sanitary frames to complete the project.

Transition to non standard diameters

Pipe connection with non-standard diameters can be connected to Marley HDPE using the Marley contraction sockets.



The contraction sockets have a variable connection diameter which shrinks and forms to the inserted pipe by applying heat. The connection is made watertight with a rubber ring and are available according to the table opposite.

Diameter (mm)	Connection diameter d _x (mm)	Code
40	41-44	S 55 04 01
40	57-64	S 55 04 02
50	57-64	S 55 05 03*
50	67-74	S 55 05 04
56	62-69	S 55 56 01*
63	62-69	S 55 06 01
63	75-79	S 55 06 03
75	80-84	S 55 07 01*
75	90-94	S 55 07 02
90	94-98	S 55 09 02
110	102-111	S 55 11 02*
110	110-120	S 55 11 03
110	115-136	S 55 11 04
125	120-140	S 55 12 01
125	135-155	S 55 12 02
160	155-165	S 55 16 02
160	160-180	S 55 16 04
200	185-207	S 55 20 01
250	236-260	S 55 25 01

*Products not in core range, but are available to order via Customer Services on 01622 852585

Sanitary

The Multikwik range includes sanitary frames, concealed cisterns and flush plates – all of the hidden things that offer reliability when designing modern washrooms.

For more information on the complete product range, visit the Multikwik website.



The HDPE soil system expands and contracts under influence of temperature changes. The pipe system therefore has to be installed correctly. This section describes the different pipe installation methods, bracket assembly methods and the correct bracket distances.

Choice of pipe installation methods

The choice of the pipe fixing system is essential to correctly install the pipe system. Depending on the temperature of the medium, the ambient temperature and the building constraints there are the following options:

1. Free moving guide bracket system with axial movement correction by means of:
 - a - Expansion sockets
 - b - Deflection leg
 - c - Deflection leg with expansion socket
2. Rigid anchor point bracket system
3. Embedding HDPE in concrete
4. Underground installation of HDPE

1. Free moving guide bracket system, with axial movement correction by means of:

A. Bracket system with expansion sockets

The axial movement is caused by the linear expansion of the pipe. The total expansion Δl triggered by the temperature difference can be calculated using equation right or can be taken from graphic drawing at the bottom of the page.

Expansion and contraction calculation

Length change caused by temperature difference

$$\Delta l_t = L_{\text{pipe}} \cdot a_t \cdot t_{\text{max}} \cdot 10^3$$

- Δl_t = Length change (mm)
- L_{pipe} = Total length of pipe (m)
- a_t = Linear expansion coefficient (mm/m $^\circ$ K)
- t_{max} = Temperature difference in $^\circ$ C

The maximum length change which can be accommodated by the expansion sockets can be found in table below

Length change with expansion sockets

d, (mm)	Code	Total length (mm)	Min. insertion depth 20 $^\circ$ C (mm)	Max. expansion (mm)	Type A (No White Retaining Ring)	Type B (With White Retaining Ring)
40	S 40 04 20	132	76	56		Type B
50	S 40 05 20	132	76	56		Type B
56	S 40 56 20	132	76	56		Type B
63	S 40 06 20	132	76	56		Type B
75	S 42 07 20	256	32	146	Type A	
90	S 42 09 20	256	33	144	Type A	
110	S 42 11 20	256	35	141	Type A	
125	S 42 12 20	256	37	139	Type A	
160	S 42 16 20	256	40	143	Type A	
200	S 40 20 20	230	120	110	Type A	

Guide bracket

The guide bracket is used to support the pipe and to prevent the pipe from buckling sideways when in a rigid installation. The pipe can freely move in the bracket.

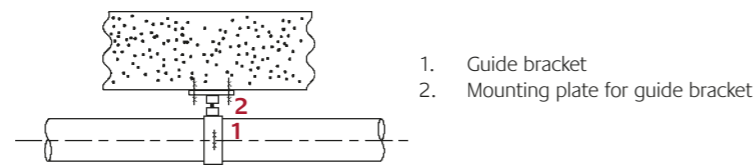

Anchor bracket with expansion socket

This method of installation is used for flexible installations where the expansion force is not transferred to the building structure. Only the force caused by the internal resistance of the expansion socket is transferred.

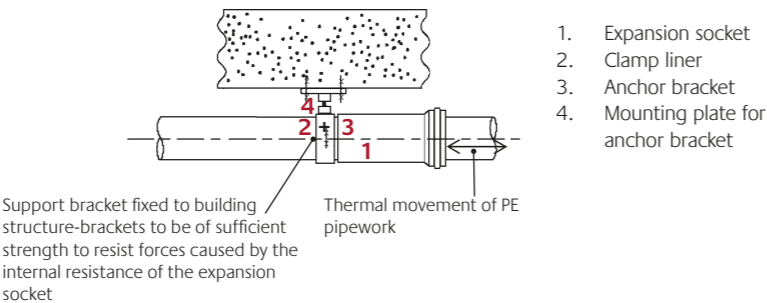

Anchor point bracket

This method of bracketing is used for rigid installations. The expansion forces are transferred to the building structure. Within the Marley product range there are two options:

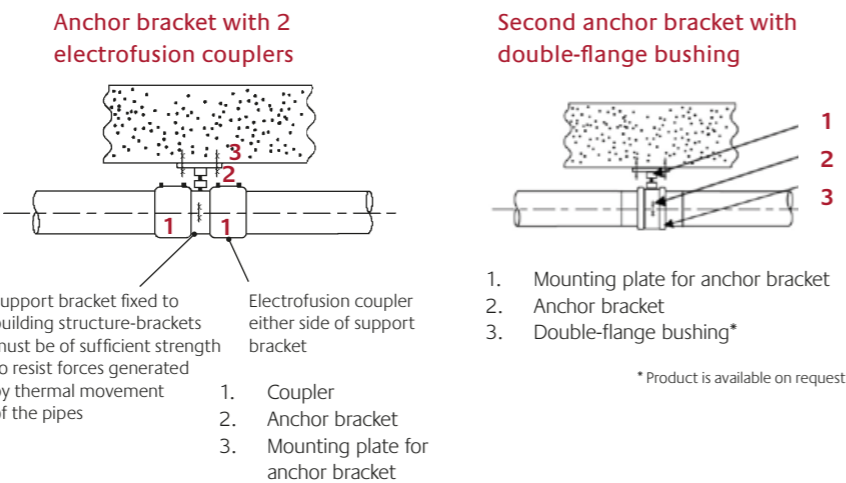

Length change caused by temperature difference

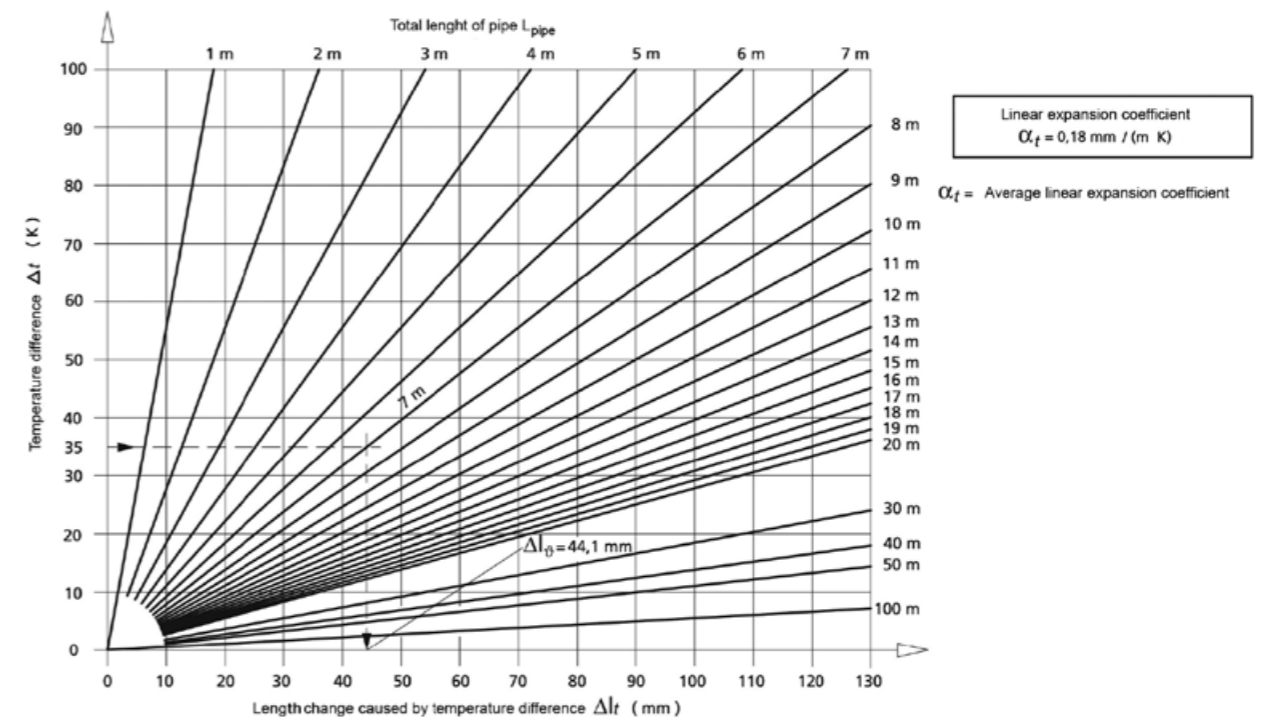

HDPE Bracketry

HDPE expansion sockets can accommodate the expansion and contraction of max. 6m. This rule of thumb can be used when no further calculations are made. This general rule is only applicable with:

$$\Delta \leq 37.5^{\circ}\text{C}.$$

The number of expansion sockets can specifically be calculated by using equitation table on previous page.

Pipe section with expansion socket

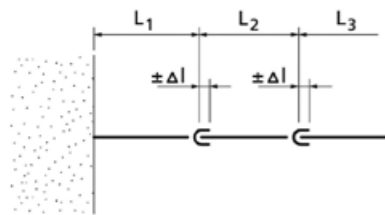

Example:

Length pipe section ($L_2 + L_3 + L_4$): 18 m

Installation temperature: 5°C

Temperature medium: +15°C / +75°C

Temperature difference: 75-5 = 70°K

Total expansion: 18 m x 0.18 mm/mK.

70K = 227 mm expansion length per expansion coupler d110 = 141mm

In a pipe section of 110 mm diameter this results in $227/141 = \sim 1.6 = 2$ expansion sockets. Therefore, based upon the calculation only 2 expansion sockets are needed as opposed to the general rule of thumb ($18/6 = 3$ expansion sockets). By calculating the maximum expansion a more cost efficient installation can be made.

With short term temperature differences, for example the emptying of a bathtub, a reduction factor of 0.5 can be applied to the temperature difference. In the example this would result in $0.5 \times 227/141 = \sim 0.8 = 1$ expansion socket.

The general rules can be applied for pipe lengths $\leq 5\text{m}$ in most drainage applications. With extreme high temperatures possibly in combination with a complex route the number of expansion sockets may need to be calculated.

Horizontal installation

The bracket directly in front of the expansion socket has a shorter bracket distance (L_A^*). This enables a better guidance into the expansion socket (see illustration below). The bracketing distances for this application can be found in table right. The maximum distance between 2 expansion sockets is 5m.

Bracket distances for horizontal installation with expansion sockets without support trays

d_1	L_A	L_A^*
50	0.8 m	0.4 m
56	0.8 m	0.4 m
63	0.8 m	0.4 m
75	0.8 m	0.4 m
90	0.9 m	0.5 m
110	1.1 m	0.6 m
125	1.3 m	0.7 m
160	1.6 m	0.8 m
200	2.0 m	1.0 m
250	2.0 m	1.0 m
315	2.0 m	1.0 m

Horizontal installation with expansion sockets without support trays

GB = guide bracket

FP = anchor point

L_A = bracket distance

L_A^* = bracket distance before expansion socket

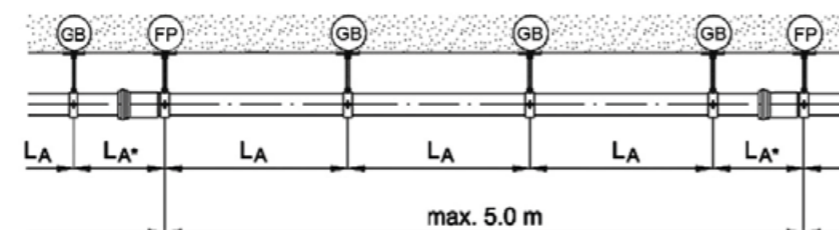

Vertical installation

The bracketry distance for vertical installation is in general 1.5 times the distance of the horizontal bracketing. There is no separate bracket distance for immediately in front of the expansion socket because there is no sagging of the pipe and the insertion is always in line.

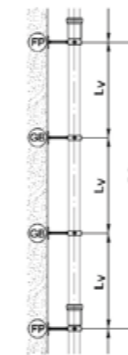

GB = guide bracket

FP = anchor point

LV = bracket distance

Bracket distances vertical installation to the wall

d_1	L_v
50	1,0 m
56	1,0 m
63	1,0 m
75	1,2 m
90	1,4 m
110	1,7 m
125	1,9 m
160	2,4 m
200	3,0 m
250	3,0 m
315	3,0 m

1B. Guide bracket system with deflection leg

Deflection leg calculation

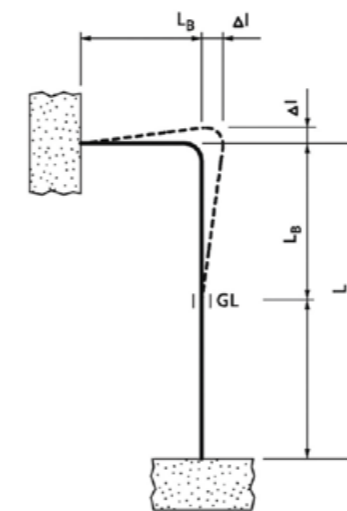

L_b = Length deflection leg

L = Pipe length

GB= Guide bracket

Δl = Length change

For calculating the length of the deflection leg, the equation below can be used or graphic drawings on page 40 depending on temperature of installation and operation.

Calculating the length of deflection leg

$$L_b \geq 10 \times \sqrt{\Delta l \times d_{1,2}}$$

L_b = Length of deflection leg (mm)

d_1 = Diameter pipe

Δl = Length change caused by expansion

First the length change Δl has to be determined at a temperature difference Δt_{max} (see expansion and contraction calculation on page 37).

Length deflection leg at operating temperature 25°C-100°C

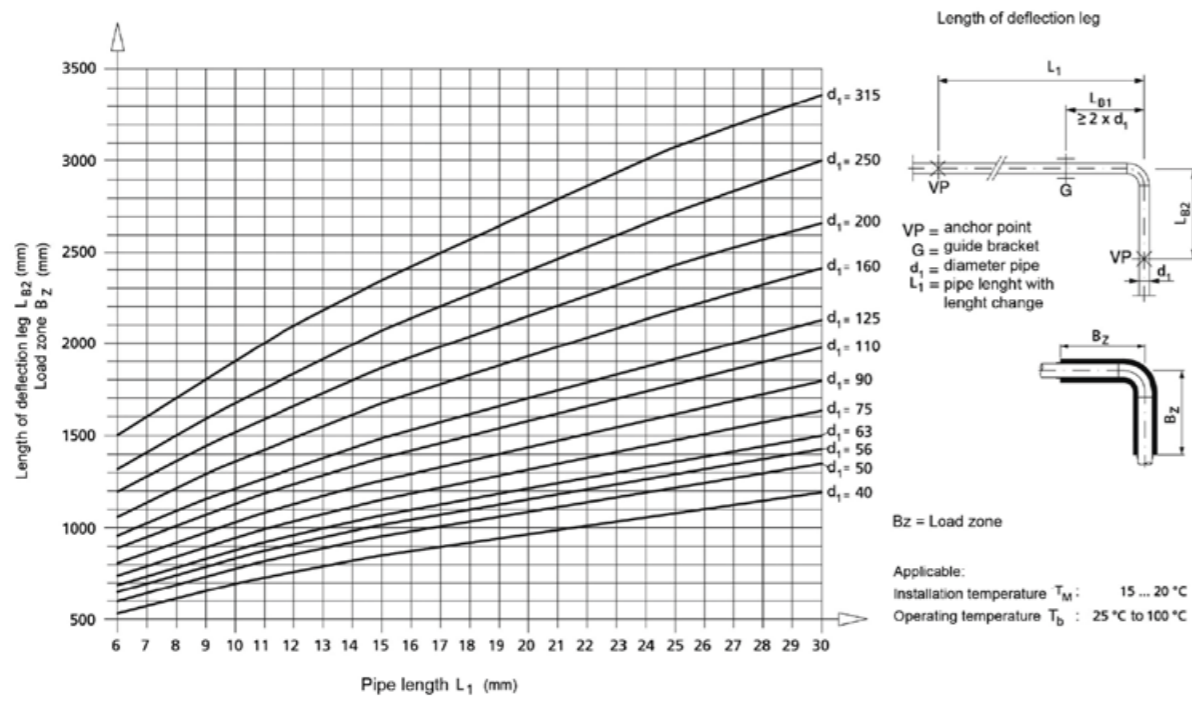

If the calculated deflection leg is shorter than the available length there will be no extra load on the pipe system. If this is not the case, an additional expansion socket needs to be installed (see section 1C on this page).

Fixing system

Check: Allowed $L_A \leq L_{B1} + L_{B2}$

Check fixing system

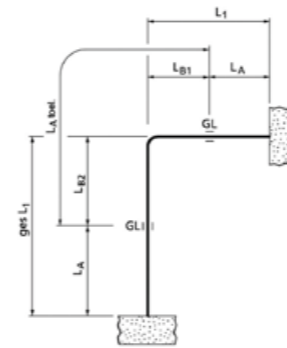

When the distance between both guide brackets is larger than the allowed bracket distance L_A , the deflection leg needs additional support to prevent sagging. This extra bracket should not hinder the working of the deflection leg. This can be done by a pendulum bracket. Bracket distance L_A can be found in the table below.

d_i	L_A
50	0.8 m
56	0.8 m
63	0.8 m
75	0.8 m
90	0.9 m
110	1.1 m
125	1.3 m
160	1.6 m
200	2.0 m
250	2.0 m
315	2.0 m

Length deflection leg at operation temperature -40°C-25°C

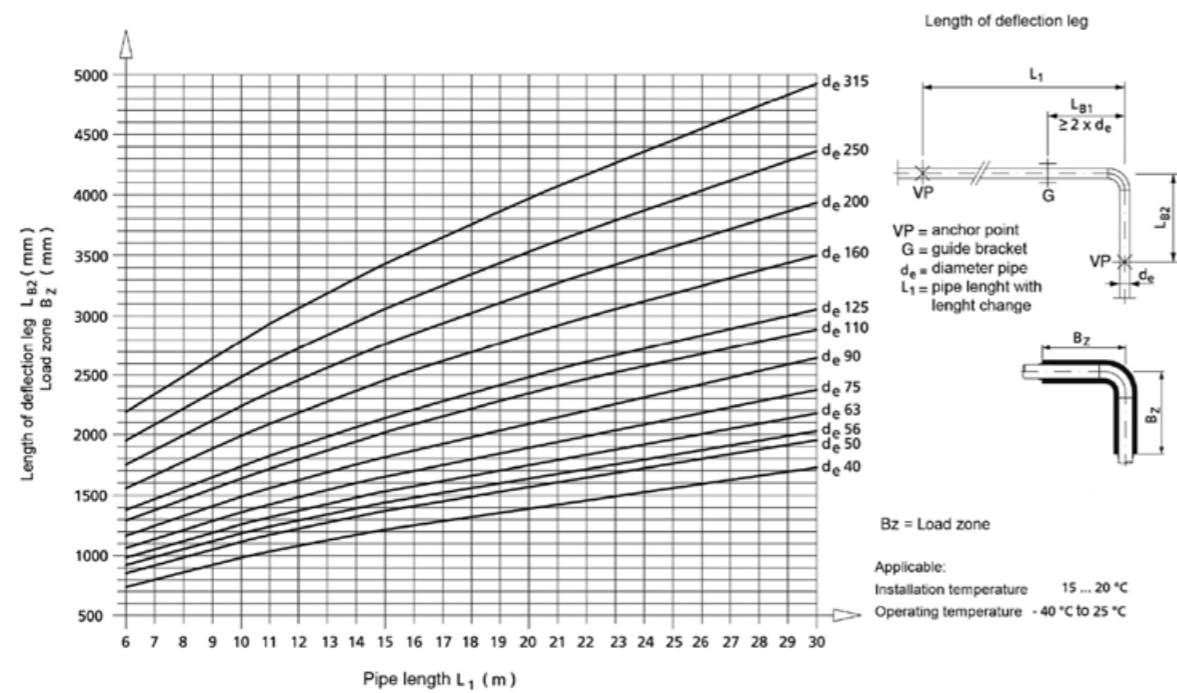

1C. Deflection leg calculation with expansion socket

When possible, a combination of a deflection leg with expansion sockets is recommended. It uses the advantages of both systems and saves expansion sockets. In the diagram right you will find an example of this.

The expansion sockets take up the expansion of pipe sections L_3 and L_4 . Several guide brackets have to be installed. The deflection leg L_{B1} and L_{B2} compensates the length change of L_1 and L_2 . When the expansion is more than can be compensated in one expansion socket a number of expansion sockets with anchor brackets need to be used.

Installation with deflection leg and expansion sockets

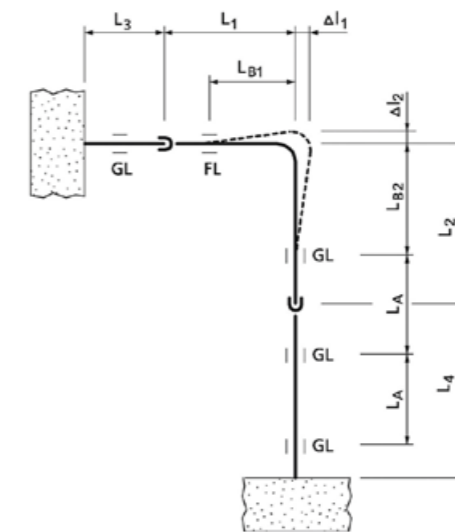

Operating temperature: +15°C/+75°C
Pipe lengths $L_1 - L_4 \leq 5$ m

2. Fixing system and thermal movement

Rigid anchor point bracket system

The bracket distances for Marley HDPE depends on the working temperature and the weight of the pipe including the medium. When the pipe is fully filled, other bracket distances are applicable (see graphic below).

Anchor point load at ambient temperature -40°C - 25°C

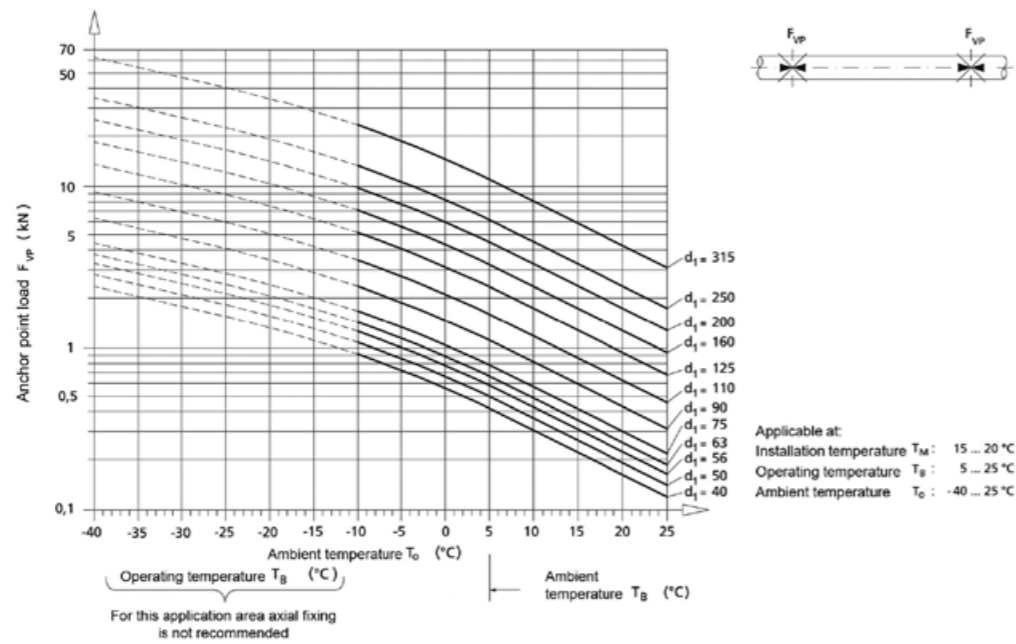

Anchor point load at ambient temperature >15°C

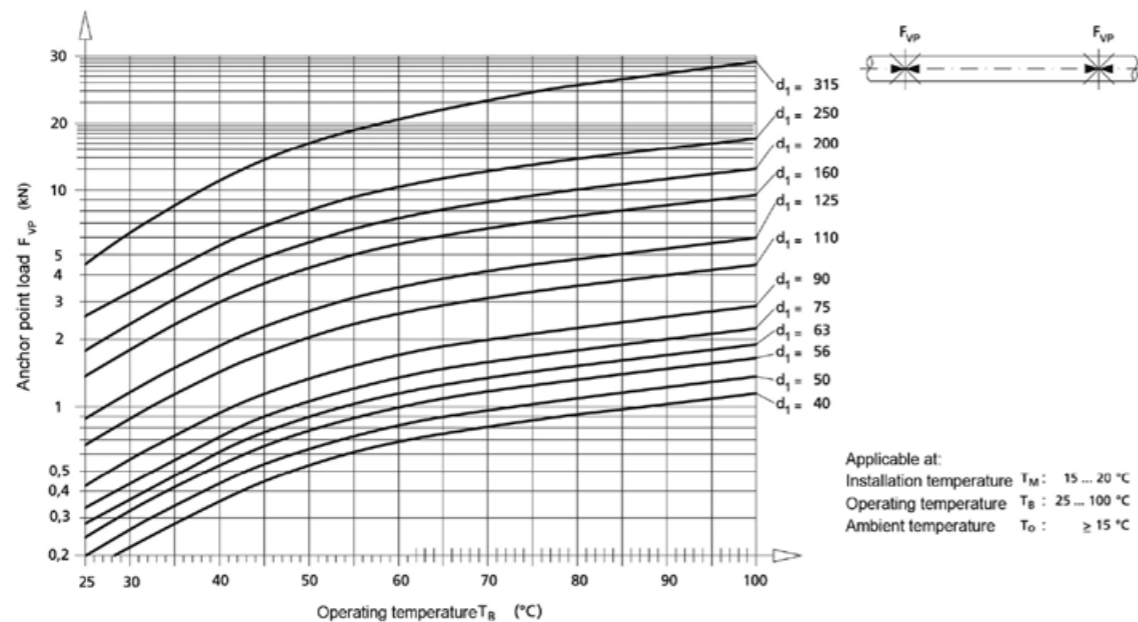

3. Embedding HDPE in concrete

Installation guidelines before pouring concrete

High density polyethylene (HDPE) is well suited to be embedded in concrete due to its physical characteristics and is guaranteed for this usage. Depending on the installation circumstances and materials used, certain installation practices are applied due to the maximum pipe strength and pipe expansion under influence of temperature changes.

HDPE pipe with s12.5 has a maximum allowed negative pressure of 800 mbar, our class s16 pipe has a maximum negative pressure of 450 mbar. When the concrete is poured and is still liquid, the outer pressure can exceed 800 mbar. To compensate this, the pipe can be filled with water and closed making it an incompressible closed system. When quick drying concrete is used, the exothermic reaction (a chemical reaction that is accompanied by the release of heat) can heat up the HDPE pipe and degrade the material and lowering the allowed negative pressure. Before pouring the concrete, the pipe system has to be secured against movement.

Expansion and contraction compensation

Because HDPE and hardened concrete do not adhere, the pipe system embedded in concrete can move freely when expanding under influence of temperature changes. All fittings installed in the pipe system act as an anchor point and are subdued to the expansion force. The concrete acts as a rigid system and the expansion and possible deformation of the fittings therefore has to be counteracted like in any HDPE installation.

When the length change of the HDPE is smaller than the shrinkage of the concrete no special precautions have to be taken however this is very rarely the case.

HDPE expansion forces in concrete

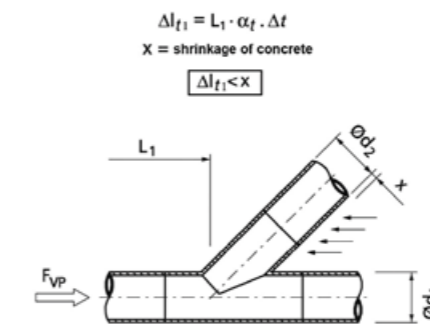

All 45° and 88.5° branches are subdued to the expansion force (FVP) which can be counteracted by installing a coupler. The coupler acts as an anchor point preventing the additional load to be transferred to the branch (see illustration below).

Anchor point with an electrofusion coupler

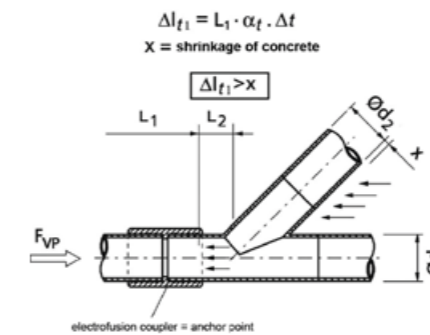

As an alternative, (snap) expansion sockets can be used. The (snap) expansion sockets act as an anchor point on one side and absorb the expansion on the other side of the socket. The snap-expansion socket can accommodate the expansion and contraction of a 5m pipe (see illustration top right).

Anchor point with expansion sockets

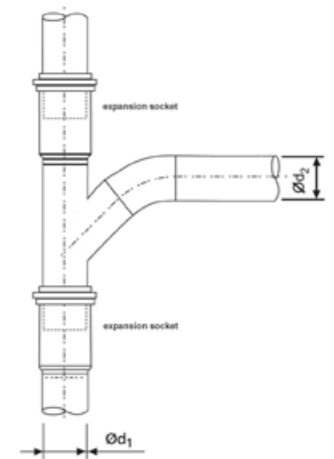

When the length of the branch is more than 2m, special precautions have to be taken as well. A fitting installed in a ceiling penetration acts as an anchor point as well. In case branches are used in a ceiling, it is recommended to use a coupler.

4. Underground installation of HDPE

Please see markings of pipes and fittings to indicate the permitted application area(s) for which they are intended:

- B: application area code for components intended for use above ground inside the building, or for components outside buildings fixed onto the wall;
- D: application code for the area under and within 1m from the building where the pipes and fittings are buried in ground and are connected to the underground drainage and sewerage system;
- BD: application area code for components intended for use for both code B and code D application areas

Installation guidelines before installing HDPE underground

Due to specific properties such as flexibility and resistance to cold temperature (freezing), HDPE pipe systems are ideal for use in underground pipe lines. Buried pipes are exposed to various loads. It is, in effect, the stability of HDPE in withstanding these pressures that makes it possible to lay the pipes at substantial depth. The suitability depends on such factors as depth, groundwater level, density of the soil and traffic load.

Soil and traffic loads

The load capacity of underground plastic pipes is based on changes in the pipe and movement of the ground. The soil load causes the top of the pipe to deflect downward. The sides of pipe are correspondingly pressed outward against the surrounding soil. The reaction pressure, the lateral force exercised on the pipe, prevents a larger cross-sectional deformation (support function). The construction of the trench, the type of bedding used and the backfilling of the trench are, to a large extent, decisive factors determining the load capacity of an underground plastic pipe. The load needs to be evenly distributed over the entire pipe line. For this reason, the trench must be created in such a manner that bends in a longitudinal direction and loads at specific points are avoided.

It is assumed that the increased pressure resulting from traffic loads caused by road or rail traffic are surface loads evenly distributed over the pipe sectional plane.

Groundwater

Underground pipes can be subject to external overpressure, especially in areas with high groundwater levels. In addition, a pipe enclosed in concrete is exposed to external pressure, though just for a short period.

Underground

Pipe systems subject to additional external pressure must be tested for the ability to withstand denting. The effective load due to external pressure will agree with the related hydrostatic pressure on the pipe axis. For special circumstances, request assistance from our Technical Services department by calling 01622 852695.

Embedding of the pipe (consolidation) – zone 2

The fill for the pipe system embedding must consist of stone-free sand or similar material: the fill must ensure optimal compacting of the ground. The embedding is, to a large extent, a decisive factor in distributing the soil pressure and load, as well as providing lateral soil pressure on the pipe with the resulting unburdening effect.

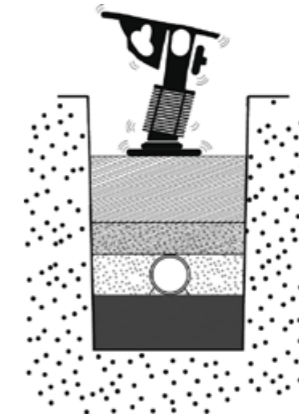

The height of zone 2 must extend to at least 150 mm above the pipe. This must also be at least 100mm above any pipe fittings.

Filling of trench (protective layer) – zone 3

The trench is backfilled in layers and compacted. Types of soil and materials that can cause dents may not be used to backfill the trench (e.g. ash, waste, stones). The use of heavy compacting equipment to compact the soil is not permissible for soil layers <1,0 m. The required thickness of zone 3 depends on trench form and pipe-wall thickness. Our Technical Support department can advise you in this regard.

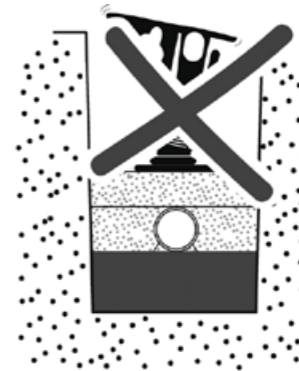

Due to the risk of the waste water freezing, the pipes must be laid at a frost-free depth.

Construction and installation of underground pipe systems

Trench base (bedding) – zone 1

The state and form of the trench base must match the mechanical properties of the thermoplastic pipe. The existing or newly constructed support layer must consist of stone-free sand that has been slightly compressed using a suitable piece of equipment. The pipe must be laid in such a way that a stable surface with at least a 90° arc of enclosure is created in order to prevent sagging or intermittent loads.

The trench in which the pipe is laid must be sufficiently narrow in order to keep the final soil pressure as low as possible. The space between pipe and trench wall must be at least 100mm.

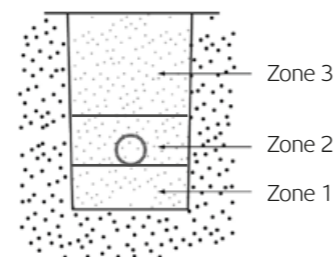

The height of zone 1 depends on the soil conditions and the nominal pipe width, and is calculated using the following equation.

$$H_{so} = H_m + \frac{DN}{10}$$

H_{so} = height of the soil in zone 1 (mm)

H_m = minimum initial thickness normal soil conditions: 100mm rocky or thick soil: 150 mm

DN = nominal pipe width (mm)

Underground

Marley offers a wide range of Underground systems:

- Solid wall system
- Quantum Sewer
- Quantum Highway
- Large diameter Quantum Highway

For more information, visit marleypd.co.uk



HDPE Bracketry

Bracket distance

The bracket distances for Marley HDPE pipes are largely dependent on the working temperature of the pipe system. Also the filling rate of the pipe plays a role. A fully filled pipe has a different bracket distance.

Bracket distances for vertical and horizontal HDPE pipe systems with standard filling

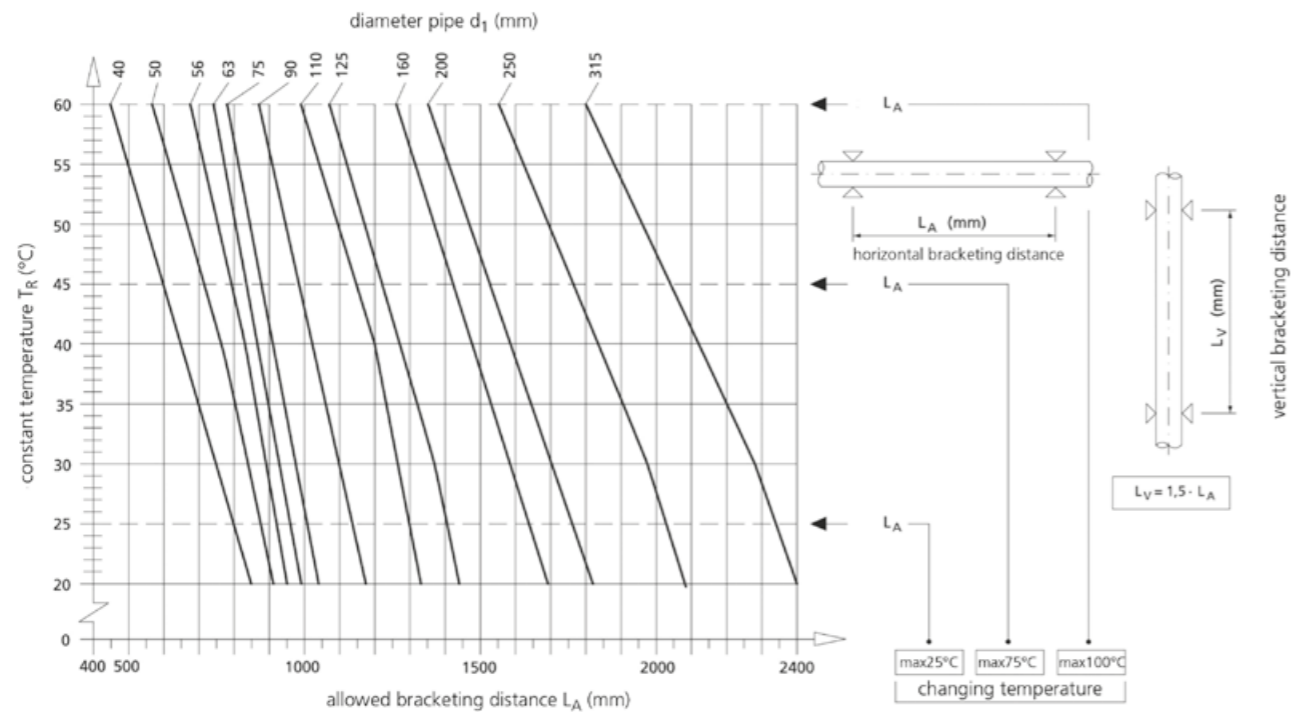

Bracket distances and weights for half filled and fully filled pipe systems at 20°C

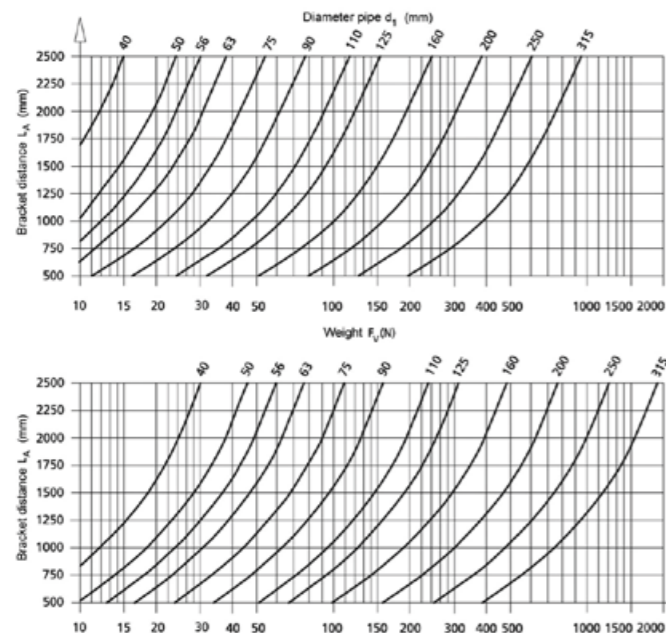

Pipe half filled		Pipe fully filled	
Pipe d_e (mm)	Weight G (N/m)	Pipe d_e (mm)	Weight G (N/m)
40	6,0	40	12,0
50	9,5	50	19,0
56	12,0	56	24,0
63	15,5	63	31,0
75	22,0	75	44,0
90	31,5	90	63,0
110	47,0	110	94,0
125	61,0	125	122,0
160	99,5	160	199,0
200	156,0	200	312,0
250	243,5	250	487,0
315	387,0	315	774,0



ACTIVE DRAINAGE VENTILATION

- Provides relief at the Point of Need
- Removes or attenuates an incoming pressure transient
- Single stack solution ideal for high-rise applications
- Eliminates the need for roof penetrations and secondary ventilation.

For more information, visit marleypd.co.uk and download the Active Drainage Ventilation guide.



Mini-Vent



Maxi-Vent



P.A.P.A.



Bracket drop distances

Distance of the bracket to the wall or ceiling

The table below shows the diameters of the connecting pipe are listed per pipe dimension and distance from the wall/floor (see image on right).

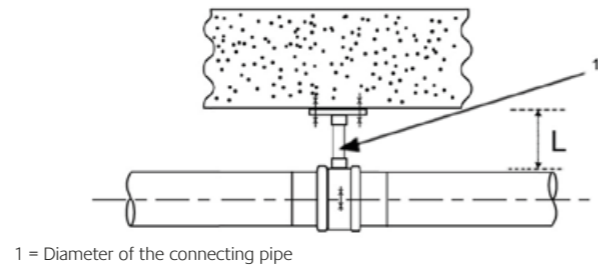

1 = Diameter of the connecting pipe

The below drop distances are provided as a guide, specific drop distances should be sourced from a suitable supplier who can verify the specific requirements for a particular application or project ensuring drop distances that are to be used are fit-for-purpose.

Distance to wall/floor L (mm)	Pipe diameter d_1								
	50	56	63	75	90	110	125	160	
100	1/2"	1/2"	3/4"	3/4"	1"	1"	1 1/4"	1 1/2"	
150	3/4"	3/4"	1"	1"	1"	1 1/4"	1 1/4"	2"	
200	3/4"	3/4"	1"	1"	1 1/4"	1 1/2"	1 1/2"	2"	
250	1"	1"	1"	1"	1 1/4"	1 1/2"	2"	-	
300	1"	1"	1 1/4"	1 1/4"	1 1/4"	2"	2"	-	
350	1 1/4"	1 1/4"	1 1/4"	1 1/4"	1 1/2"	2"	2"	-	
400	1 1/4"	1 1/4"	1 1/4"	1 1/4"	1 1/2"	2"	-	-	
450	1 1/4"	1 1/4"	1 1/2"	1 1/2"	2"	2"	-	-	
500	1 1/4"	1 1/4"	1 1/2"	1 1/2"	2"	-	-	-	
550	1 1/4"	1 1/4"	1 1/2"	1 1/2"	2"	-	-	-	
600	1 1/2"	1 1/2"	1 1/2"	1 1/2"	2"	-	-	-	

When the pipe is larger than 160mm, a special construction is needed and has to be dimensioned.

General bracketry guidance

Horizontal installation

Because the pipe generates different forces with different dimensions, the anchor brackets have to be placed at dimension changes, branches and on the beginning and end of a pipe section.

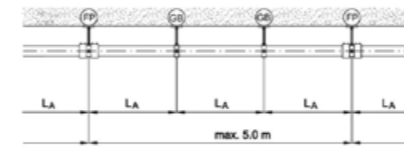

Vertical installation

The bracketing distance for vertical installation is in general 1.5 times the distance of the horizontal bracketing.

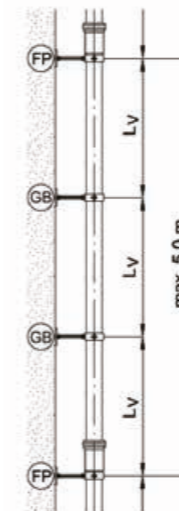

Bracket distances for horizontal and vertical installations with anchor brackets

d_1	L_A	L_V
50	0.8 m	1.0 m
56	0.8 m	1.0 m
63	0.8 m	1.0 m
75	0.8 m	1.2 m
90	0.9 m	1.4 m
110	1.1 m	1.7 m
125	1.3 m	1.9 m
160	1.6 m	2.4 m
200	2.0 m	3.0 m
250	2.0 m	3.0 m
315	2.0 m	3.0 m

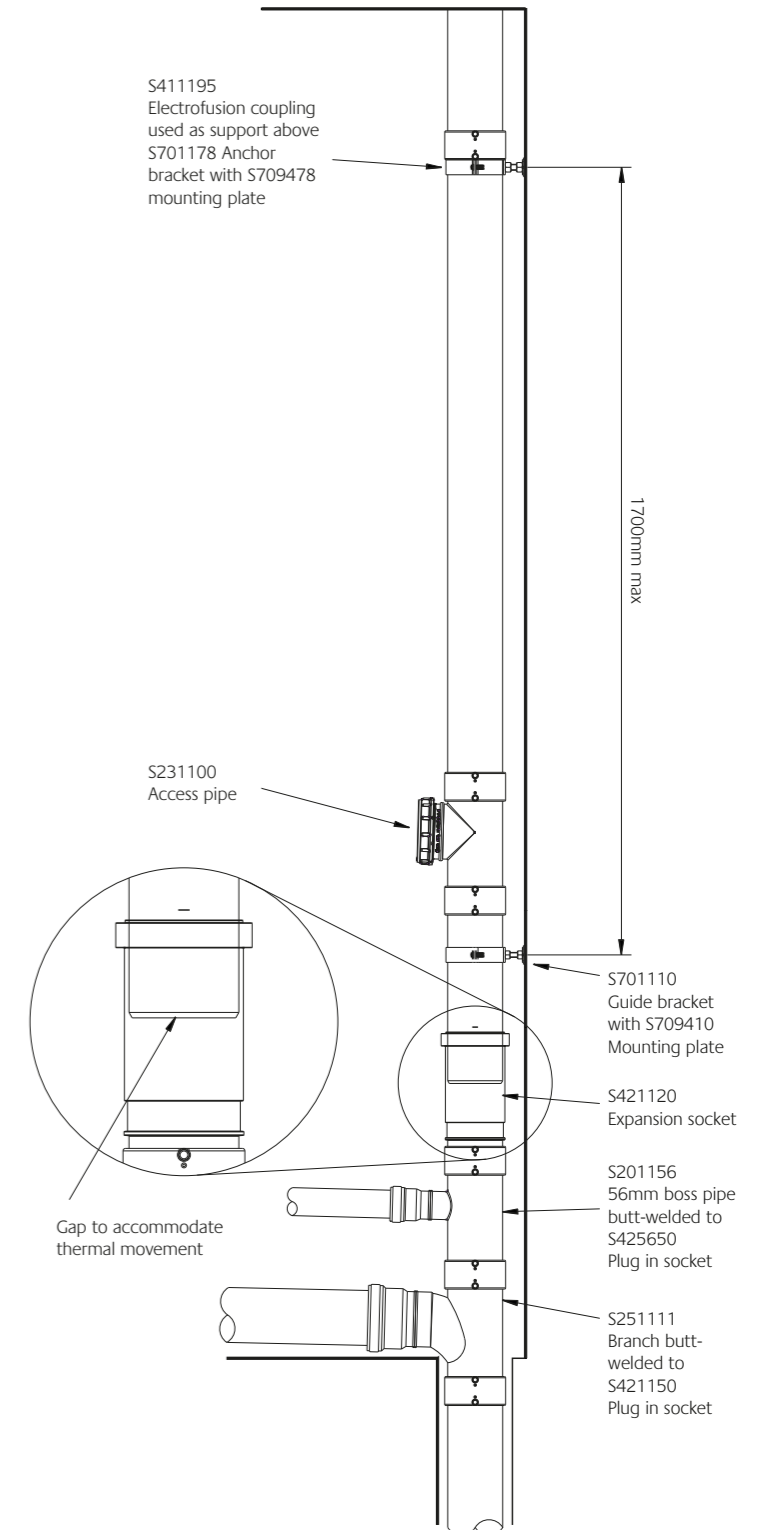

GB = guide bracket FP = anchor point L_A = bracket distance

Typical single stack installation with bracket distances

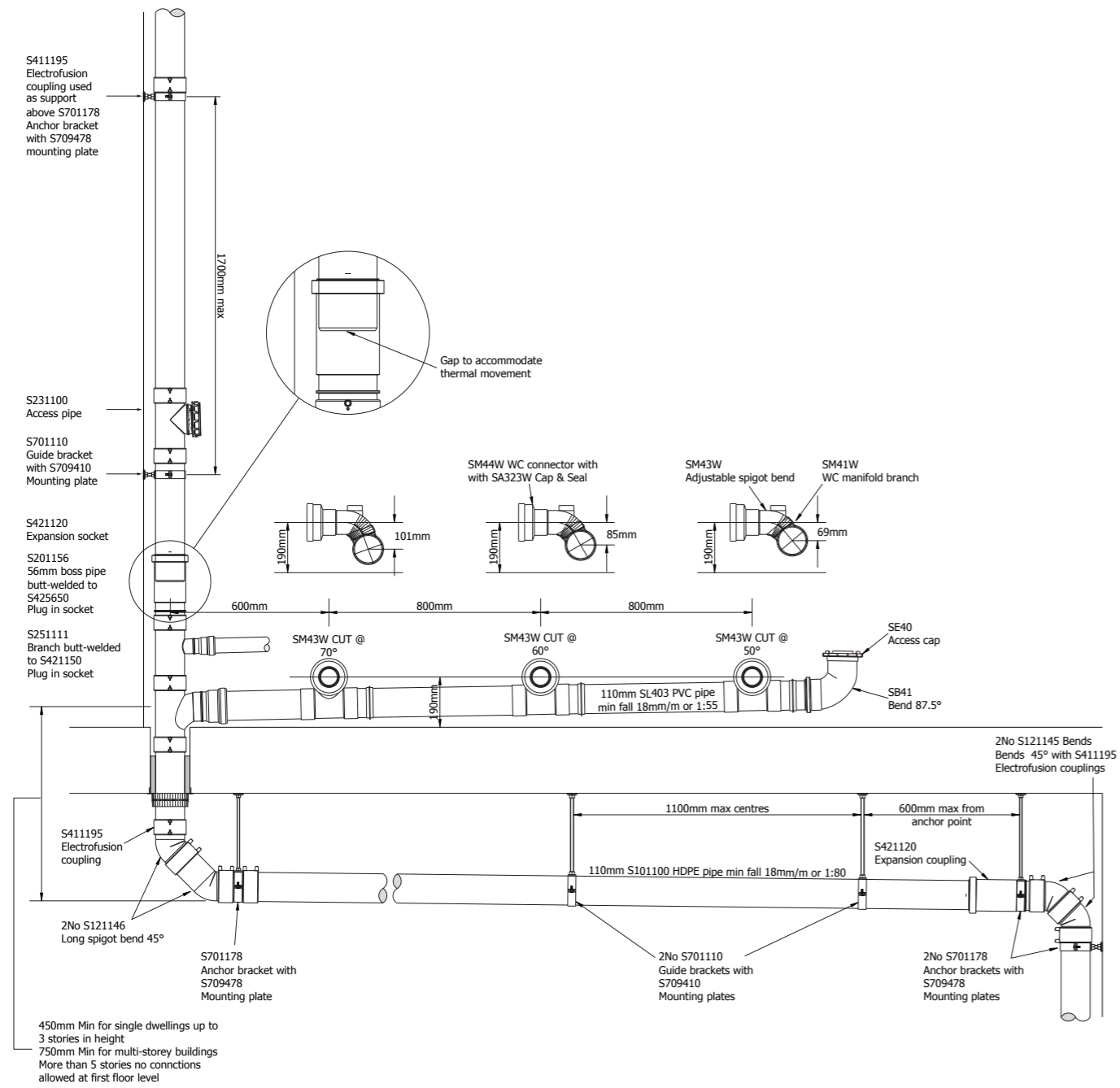

Typical secondary vented stack installation with bracket distances

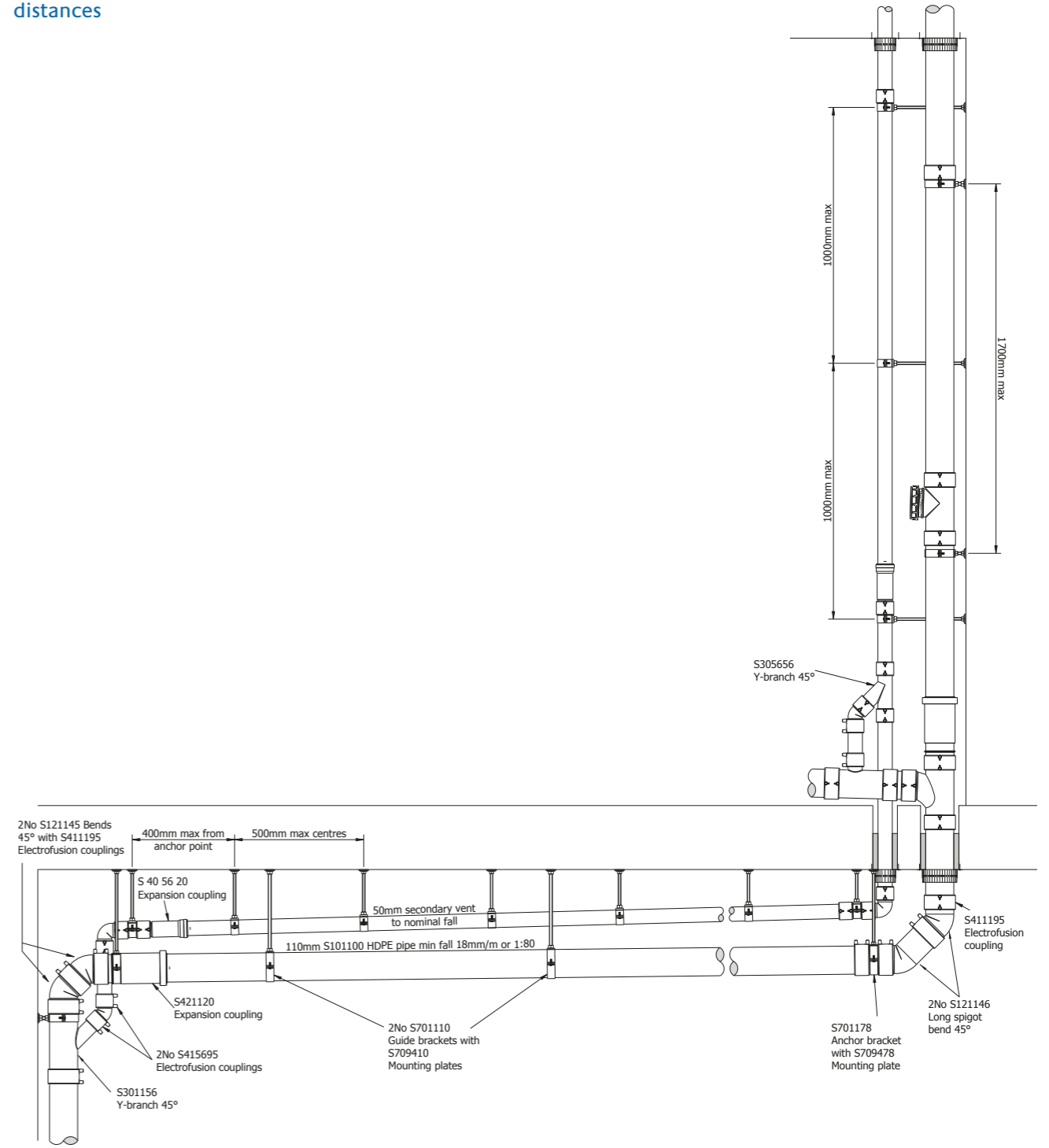

Chemical resistance

The chemical resistance of HDPE is depicted per medium at a number of different temperatures. In general we can define the resistance as follows:

For standard soil and waste systems the resistance of HDPE is perfect. In these pipes systems hardly ever aggressive fluids are drained. When transporting chemical waste waters, the following factors have to be taken in account:

- medium
- concentration of this medium
- temperature
- duration of exposure
- volume

The chemical resistance list of the electrometric seals is to aid in establishing the suitability of a certain seal. This is only an indication of its suitability. The chemical deterioration of the polymer chain can lead to changes in the mechanical characteristics like tensile strength and elongation at break etc. The data is valid for a temperature of 20°C. At higher temperatures or longer duration of exposure a more aggressive condition can occur which shortens the lifespan of the seal.

Used symbols

HDPE pipe and fittings:

- +** Resistant, based on the test carried out I.
- a** Suitable material for this application.
- /** Limited resistance, further research necessary.
- No resistance.

Elastomeric seals:

- 1 Little or no effect, volume change <10%. In heavy conditions this elastomere can show a small increase in volume and /or loss of physical properties.
- 2 Possible change of physical properties, volume change 10%-20%, the elastomere can show increase in volume and a change in physical properties but can be suitable for static applications.
- 3 Noticeable change of physical properties, large change in volume, and physical properties.
- 4 Elastomeric seal is not suitable. Influence too much.

Abbreviations:

Comm. Comp.= Commercial composition

HDPE = High density polyethylene

NBR = Acryl nitrile-butadiene rubber

EPDM = Ethylene propylene copolymer

FPM = Vinylidene fluoride copolymer

SBR = Styrol butadiene rubber

TPE = Thermoplastic elastomer

Component	Name	Formula	Remark	Concentration	Pipe and fittings			Elastomeric seals			
					HDPE			NBR	EPDM	FPM	SBR
					20	40	60	°C	°C	°C	°C
	Acetaldehyde	CH ₃ CHO	Aqueous solution	40%	+	+	/	4	2	4	3
	Acetaldehyde	CH ₃ CHO	Technically pure	100%	+	/	/	4	2	4	3
	Acetic Acid	CH ₃ COOH	Aqueous solution	10%	+	+	+	4	3/4	4	4
	Acetic Acid	CH ₃ COOH	Aqueous solution	30%	+	+	+	4	4	4	4
	Acetic Acid	CH ₃ COOH	Aqueous solution	60%	+	+	+	4	4	4	4
	Acetic Acid	CH ₃ COOH	Aqueous solution	80%	/	/	-	4	4	4	4
	Acetic Acid	CH ₃ COOH	Technically pure	100%	+	+	/	4	4	4	4
	Acetic Acid Anhydride	(CH ₃ CO) ₂ O	Technically pure	100%	+	/		4	2	4	2
	Acetone	CH ₃ COCH ₃	Aqueous solution	10%	+	+	+	4	1	4	2/3
	Acetone	CH ₃ COCH ₃	Technically pure	100%	/	/		4	1	4	2/4
	Acetophenone	CH ₃ COC ₆ H ₅	Technically pure	Indetermined	+	+	+	4	1	4	4
	Acrylonitrile	CH ₂ =CH-CN	Technically pure	100%	+	+	+	4	4	4	3
	Adipic Acid	HOOC(CH ₂) ₄ COOH	Aqueous solution	Saturated	+	+	+	1	1	1	1
	Alcohol			40%	+						
	Alcoholic Spirits			Comm. Comp.	+	+					
	Allyl Alcohol	CH ₂ =CH-CH ₂ OH	Aqueous solution	96%	+	+	+				
	Alum	Al ₂ (SO ₄) ₃ ·K ₂ SO ₄ ·4H ₂ O	Aqueous solution	Solution	+	+	+	2	1	1	1
	Alum	Al ₂ (SO ₄) ₃ ·K ₂ SO ₄ ·4H ₂ O	Aqueous solution	Saturated	+	+	+	2	1	1	1
	Aluminium Acetate	(CH ₃ COO) ₂ Al	Aqueous solution	Saturated	+	+	+	2	1	4	4
	Aluminium Bromide	AlBr ₃	Aqueous solution	Saturated	+	+	+	1	1	1	1
	Aluminium Chloride	AlCl ₃	Aqueous solution	All	+	+	+	2	1	1	1
	Aluminium Fluoride	AlF ₃	Aqueous solution	Saturated	+	+	+	2	1	1	1
	Aluminium Nitrate	Al(NO ₃) ₃	Aqueous solution	Saturated	+			1	1	1	1
	Aluminium Sulfate	Al ₂ (SO ₄) ₃	Aqueous solution	10%	+	+	+	2	1	1	1
	Aluminium Sulfate	Al ₂ (SO ₄) ₃	Aqueous solution	Saturated	+	+	+	2	1	1	1
	Ammonia	NH ₃	Aqueous solution	Solution	+	+	+	2	1	3	2
	Ammonia Gas	NH ₃	Aqueous solution	Saturated	+	+	+	2	1	3	2
	Ammonia Gas	NH ₃	Technically pure	100%	+	+	+	2	1	3	2
	Ammonium Acetate	CH ₃ COONH ₄	Aqueous solution	Saturated	+	+	+				
	Ammonium Bifluoride	NH ₄ FHF	Aqueous solution	Saturated	+	+	+				
	Ammonium Carbonate	(NH ₄) ₂ CO ₃	Aqueous solution	100%	+	+	+	2	1	2	2
	Ammonium Chloride	NH ₄ Cl	Aqueous solution	Saturated	+	+	+	1	1	1	1
	Ammonium Fluoride	NH ₄ F	Aqueous solution	25%	+	+	+	1	1	1	1
	Ammonium Fosfate	(NH ₄) ₃ PO ₄ ·X H ₂ O		All	+	+	+	1	1	1	1
	Ammonium Hydroxide	NH ₄ OH	Aqueous solution	Solution	+	+	+	4	1	2	4
	Ammonium Hydroxide	NH ₄ OH	Aqueous solution	Saturated	+	+	+	4	1	2	4
	Ammonium Nitrate	NH ₄ NO ₃	Aqueous solution	Saturated	+	+	/	2	1	1	1
	Ammonium Sulfate	(NH ₄) ₂ SO ₄	Aqueous solution	All	+	+	+	1	1	1	1
	Ammonium Sulphhydrate	NH ₄ OH(NH ₄) ₂ SO ₄	Aqueous solution	Solution	+						
	Ammonium Sulphhydrate	NH ₄ OH(NH ₄) ₂ SO ₃	Aqueous solution	Saturated	+						
	Ammonium Sulfide	(NH ₄) ₂ S	Aqueous solution	10%	+	+	+	1	1	1	1
	Ammonium Sulfide	(NH ₄) ₂ S	Aqueous solution	Saturated	+	+	+	1	1	1	1
	Amyl Acetate	CH ₃ COO(CH ₂) ₄ CH ₃	Technically pure	100%	+	+	+	4	2	4	3
	Amyl Alcohol	CH ₃ (CH ₂) ₄ CH ₂ OH	Technically pure	100%	+	+	/	2	2	2	1
	Amyl Chloride	CH ₃ (CH ₂) ₄ Cl	Technically pure	100%	-			4	1	4	4
	Aniline	C ₆ H ₅ NH ₂	Technically pure	100%	/			4	2/3	1	3
	Aniline Chlorhydrate	C ₆ H ₅ NH ₂ HCl	Aqueous solution	Saturated	/	/	/	2	2	1	1
	Anthraquinone Sulfonic Acid			Solution	+						
	Antimony Trichloride	SbCl ₃	Aqueous solution	90%	+	+	+	1	1	1	1
	Aqua Regia	₃ HCl+HNO ₃		100%	-	-	-	4	4	2/3	4
	Arsenic Acid	H ₃ AsO ₄		Saturated	+	+					
	Barium Carbonate	BaCO ₃	Aqueous solution	All	+	+	+				
	Barium Chloride	BaCl ₂	Aqueous solution	All	+	+	+	1	1	1	1
	Barium Hydroxide	Ba(OH) ₂	Aqueous solution	Saturated	+	+	+	1	1	1	1
	Barium Nitrate	Ba(NO ₃) ₂	Aqueous solution	Saturated	+	+	+				
	Barium Sulfate	BaSO ₄	Aqueous solution	Saturated	+	+	+	1	1	1	1
	Barium Sulfide	BaS	Aqueous solution	Saturated	+	+	+	1	1	1	2
	Beer			100%	+	+	+	1	1	1	1
	Benzaldehyde	C ₆ H ₅ CHO	Aqueous solution	Saturated	+	+	+	4	2	4	3
	Benzene	C ₆ H ₆	Technically pure	100%	/	-	-	4	4	3	4
	Benzene + Benzine			20/80%	/	-	-	2/3	4	2	4

Component	Name	Formula	Remark	Concentration	Pipe and fittings			Elastomeric seals			
					HDPE °C			NBR °C	EPDM °C	FPM °C	SBR °C
					20	40	60	20	20	20	20
Furfuryl Alcohol	C ₅ H ₆ O ₂	Technically pure	100%	+	+	/	4	2		4	
Gelatine			100%	+	+	+	1	1	1	1	
Glycerine	C ₃ H ₅ (OH) ₃	Aqueous solution	All	+	+	+	1	1	2	1	
Glycocol	NH ₂ CH ₂ COOH	Aqueous solution	10%	+	+						
Glycolic Acid	HOCH ₂ COOH	Aqueous solution	37%	+	+	+					
Gas containing:											
- Carbon Dioxide	CO ₂	Gas	All	+	+	+					
- Carbon Monoxid	CO	Gas	All	+	+	+					
- Hydrochloric Acid	HCL	Gas	All	+	+	+					
- Hydrochloric Acid	HCL	Gas	All	+	+	+					
- Hydrofluoric Acid	HF	Gas	< 0,1%	+	+	+					
- Nitrous Vapours	NO, NO ₂ , N ₂ O ₃ , NOx	Gas	< 0,1%	+	+	+					
- Nitrous Vapours	NO, NO ₂ , N ₂ O ₃ , NOx	Gas	5%	+	+	+					
- Oleum	H ₂ SO ₄ + SO ₃	Gas	< 0,1%	-	-	-					
- Oleum	H ₂ SO ₄ + SO ₃	Gas	5%	-	-	-					
- Sulphur Dioxide Liquid	SO ₂	Gas	All	+	+	+					
- Sulphur Trioxide	SO ₃	Gas	< 0,1%	-	-	-					
- Sulphuric Acid	H ₂ SO ₄	Gas	All	+	+	+					
Heptane	C ₇ H ₁₆	Technically pure	100%	+	/	-	1	4	1	4	
Hexane	C ₆ H ₁₄	Technically pure	100%	+	/	/	1	4	1	4	
Hydrazine Hydrate	NH ₂ -NH ₂ ·H ₂ O	Aqueous solution	Solution	+	+	+		2	1	1	
Hydrobromic Acid	HBr		10%	+	+	+	3	2	1	3	
Hydrobromic Acid	HBr		48%	+	+	+	4	1	1	4	
Hydrochloric Acid	HCl	Aqueous solution	10%	+	+	+					
Hydrochloric Acid	HCl	Aqueous solution	30%	+	+	+	2/3	1	2	2/3	
Hydrochloric Acid	HCl	Aqueous solution	5%	+	+	+					
Hydrochloric Acid	HCl	Aqueous solution	Saturated	+	+	+					
Hydrocyanic Acid	HCN	Aqueous solution	Solution	+	+	+	2	2	1	2	
Hydrocyanic Acid	HCN	Technically pure		+	+	+	2	2	1	2	
Hydrofluoric Acid	HF	Aqueous solution	10%	+	+	/	4	3	2/3	3	
Hydrofluoric Acid	HF	Aqueous solution	40%	+	/	/	4	3	2/3	3	
Hydrofluoric Acid	HF	Aqueous solution	70%	+	/	/	4	3	2/3	3	
Hydrogen Gas	H ₂		100%	+	+	+	2	1	1	4	
Hydrogen Peroxide	H ₂ O ₂	Aqueous solution	10%	+	+	+	2	1	1	2	
Hydrogen Peroxide	H ₂ O ₂	Aqueous solution	50%	+	+	/	2	1	1	2	
Hydrogen Peroxide	H ₂ O ₂	Aqueous solution	90%	+	-	-	2	1	1	2	
Hydrogen Sulfide	H ₂ S	Aqueous solution	Saturated	+	+	+					
Hydrogen Sulfide	H ₂ S		100%	+	+	/					
Hydroquinone	C ₆ H ₄ O ₂	Aqueous solution	Saturated	+	+	+	3	4	2	4	
Hydroxylamine Sulphate	(NH ₂ OH) ₂ ·H ₂ SO ₄	Aqueous solution	All	+	+	+					
Iodine Dry And Wet	I ₂		3%	/	-	-	1	2	1	1	
Iso-Octane	C ₈ H ₁₈		100%	/	/	-	1	4	1	4	
Isopropyl Alcohol	(CH ₃) ₂ CHOH	Technically pure	100%	+	+	+	2	1	1	2	
Isopropyl Ether	(CH ₃) ₂ CHOCH(CH ₃) ₂	Technically pure	100%	/	-	-	2/3	3	4	4	
Lactic Acid	CH ₃ CHOHCOOH	Aqueous solution	<=28%	+	+	+	2	1	1	3	
Lanoline			Comm. Comp.	+	+	+	1	4	1	4	
Lard Oil			Comm. Comp.	+							
Lead Acetate	Pb(CH ₃ COO) ₂	Aqueous solution	Saturated	+	+	+	1	1	4	4	
Lead Chloride	PbCl ₂	Aqueous solution	Saturated	+	+						
Lead Nitrate	Pb(NO ₃) ₂	Aqueous solution	Saturated	+	+	+	1	1	1	1	
Lead Sulfate	PbSO ₄	Aqueous solution	Saturated	+	+	+					
Linseed Oil			Comm. Comp.	/			1	3	1	4	
Lubricating Oils			Comm. Comp.	-			2	4	1	4	
Lubricating Oils, Free Of Aromatic			Comm. Comp.	+	+	/	1	4	1	4	
Magnesium Carbonate	MgCO ₃	Aqueous solution	All	+	+	+	1	1	1	1	
Magnesium Chloride	MgCl ₂	Aqueous solution	Saturated	+	+	+	2	1	1	1	
Magnesium Nitrate	Mg(NO ₃) ₂	Aqueous solution	Indetermined	+	+	+					
Magnesium Sulfate	MgSO ₄		Saturated	+	+	+	2	1	1	1	
Maize Oil			Comm. Comp.	+	+	/	1	1	1	4	
Maleic Acid	HOOC-CH=CH-COOH	Aqueous solution	Saturated	+	+	+	1	1	1	1	
Malic Acid	HOOCCH ₂ CHOHCOOH	Aqueous solution	Saturated	+			1	4	1	2	

Component	Name	Formula	Remark	Concentration	Pipe and fittings			Elastomeric seals			
					HDPE °C			NBR °C	EPDM °C	FPM °C	SBR °C
					20	40	60	20	20	20	20
Sodium Bisulfite	NaHSO ₃	Aqueous solution	100%	+	+	+	1	1	1	2	
Sodium Bromate	NaBrO ₃	Aqueous solution	All	+	/						
Sodium Bromide	NaBr	Aqueous solution	Saturated	+	+	+					
Sodium Carbonate (Soda)	Na ₂ CO ₃	Aqueous solution	Saturated	+	+	+	2	1	1	1	
Sodium Chlorate	NaClO ₃	Aqueous solution	All	+	+	+	2/3	2	1	4	
Sodium Chloride	NaCl	Aqueous solution	Solution	+	+	+	1	1	1	1	
Sodium Chloride	NaCl	Aqueous solution	Saturated	+	+	+	1	1	1	1	
Sodium Chromate	Na ₂ CrO ₄	Aqueous solution	Solution	+							
Sodium Cyanide	NaCN	Aqueous solution	All	+	+	+	2	1	1	1	
Sodium Disulphite	Na ₂ S ₂ O ₅	Aqueous solution	All	+			1	1	1	2	
Sodium Ferrocyanide	Na ₄ Fe(CN) ₆	Aqueous solution	Saturated	+	+						
Sodium Fluoride	NaF	Aqueous solution	Saturated	+							
Sodium Hydroxide	NaOH	Aqueous solution	10%	+	+	+	3	1	2	2	
Sodium Hydroxide	NaOH	Aqueous solution	30%	+	+	+	4	1	3	2	
Sodium Hydroxide	NaOH	Aqueous solution	50%	+	+	+	1	1	3	2	
Sodium Hypochlorite	NaClO	Aqueous solution	12,50%	/	-		4	1	1	4	
Sodium Hypochlorite	NaClO	Aqueous solution	3%	+	/	/	4	1	1	4	
Sodium Iodide NaI		Aqueous solution	All	+							
Sodium Metasilicate	Na ₂ SiO ₃	Aqueous solution	<5%	+	+	+					
Sodium Metasilicate	Na ₂ SiO ₃	Aqueous solution	Saturated	+	+	+	1	1	1	1	
Sodium Nitrate	NaNO ₃	Aqueous solution	Saturated	+	+	+	1	1	1	1	
Sodium Nitrite	NaNO ₂	Aqueous solution	Saturated	+							
Sodium Oxalate	Na ₂ C ₂ O ₄	Aqueous solution	Saturated	+							
Sodium Perborate	NaBO ₃	Aqueous solution	All	+			2	1	1	2	
Sodium Perchlorate	NaClO ₄	Aqueous solution	Indetermined	+							
Sodium Peroxide	Na ₂ O ₂		Solution	+			2	1	1	2	
Sodium Persulphate	Na ₂ S ₂ O ₈	Aqueous solution	Saturated	+	+	+					
Sodium Phosphate	Na ₃ PO ₄	Aqueous solution	Saturated	+	+	+	1	1	1	1	
Sodium Phosphate Monoacid	Na ₂ HPO ₄	Aqueous solution	Saturated	+	+	1	1	1			
Sodium Sulfate	Na ₂ SO ₄	Aqueous solution	Saturated	+	+	+	1	1	1	1	
Sodium Sulfide	Na ₂ S	Aqueous solution	Solution	+	+	+	2	1	1	3	
Sodium Sulfide	Na ₂ S	Aqueous solution	Saturated	+	+	+	2	1	1	3	
Sodium Sulfite	Na ₂ SO ₃	Aqueous solution	Saturated	+	+	+					
Sodium Thiocyanate	NaSCN	Aqueous solution	Indetermined	+	+	+					
Sodium Thiosulphate	Na ₂ S ₂ O ₃	Aqueous solution	Saturated	+	+	+	3	1	1	2	
Stannic Chloride	SnCl ₄	Aqueous solution	Saturated	+	+	+	1	1	1	2	
Stannous Chloride	SnCl ₂	Aqueous solution	Saturated	+	+	+	1	1	1	1	
Stearic Acid	C ₁₇ H ₃₅ COOH	Technically pure	100%	+	/		1	1	1	1	
Styrene	C ₆ H ₅ CH=CH ₂		100%	/	-	-	4	4	1	4	
Sugar Syrup			Saturated	+	+	+	1	1	1	1	
Sulfamic Acid	HSO ₃ NH ₂	Aqueous solution	20%	-							
Sulphur	S		100%	+	+	+					
Sulphur Dioxide Liquid	SO ₂	Aqueous solution	Saturated	+	+	+	+				
Sulphur Dioxide Liquid	SO ₂	Technically pure	100%	-							
Sulphur Dioxide Liquid	SO ₂	Technically pure	100%	+	+	+	+				
Sulphur Trioxide	SO ₃		100%	-							
Sulphuric Acid	H ₂ SO ₄	Aqueous solution	10%	+	+	+	2	1	2	2	
Sulphuric Acid	H ₂ SO ₄	Aqueous solution	50%	+	+	+	4	1	2	4	
Sulphuric Acid	H ₂ SO ₄	Aqueous solution	80%	+	+	/	4	2	2	4	
Sulphuric Acid	H ₂ SO ₄	Aqueous solution	90%	/	/	-					
Sulphuric Acid	H ₂ SO ₄	Aqueous solution	96%	-	-	-	4	4	2	4	
Sulphuric Acid	H ₂ SO ₄	Aqueous solution indetermined	98%	-	-	-					
Sulphuric Acid	H ₂ SO ₄	Technically pure	100%	-	-	-					
Sulphurous Acid	H ₂ SO ₃	Aqueous solution	Saturated	+	+	+	2	2	1	2	
Tallow Emulsion			Comm. Comp.	+	/	/	2	2	1	4	
Tannic Acid	C ₇₆ H ₅₂ O ₄₆	Aqueous solution	All	+	+	+	2	2	2	2	
Tartaric Acid	COOH(CHOH) ₂ COOH	Aqueous solution	All	+	+	+					
Tetrachloroethane	CHCl ₂ CHCl ₂		100%	-			4	4	1	4	
Tetrachloroethylene	Cl ₂ C=CCl ₂		100%	/			4	4	2	4	
Tetraethyl Lead	Pb(C ₂ H ₅) ₄	Technically pure	100%	+			2	4	1	4	

Component Name	Formula	Remark	Concentration	Pipe and fittings			Elastomeric seals			
				HDPE			NBR °C	EPDM °C	FPM °C	SBR °C
				20	40	60				
Tetrahydrofurane	(CH ₂) ₄ O		100%	/	-		4	4	4	4
Tetrahydronaphthalene	C ₁₀ H ₁₂		100%	/						
Thionyl Chloride	SOCl ₂	Technically pure	100%	-			2/3	1	1	2/3
Thiophene	C ₄ H ₄ S	100%	/	/			4	4	4	4
Toluene	C ₆ H ₅ CH ₃	Technically pure	100%	/	-	-	4	4	2	4
Toluic Acid	CH ₃ C ₆ H ₄ COOH		50%	/						
Transformer Oil			Comm. Comp.	+	/	/		4	2	4
Tributylphosphate	(C ₄ H ₉) ₃ PO ₄	Technically pure	100%	+	+	+	4	2	3	4
Trichlorethylene	ClCH=CCl ₂	Technically pure	100%	-	-	-	4	4	2	4
Trichloroacetic Acid	CCl ₃ COOH	Aqueous solution	50%	+	/	/	2	2	4	4
Trichloroacetic Acid	CCl ₃ COOH	Technically pure	100%	+	/	-	2	2	4	4
Trichloroethane	CH ₃ CCl ₃	Technically pure	100%	/			4	4	1	4
Tricresylphosphate	(CH ₃ C ₆ H ₄) ₃ PO ₄	Technically pure	100%	+	+	+	4	2	2	4
Triethanolamine	N(CH ₂ CH ₂ OH) ₃	Technically pure	100%	+	+	/	3	1	4	2
Triocetylphosphate	(C ₈ H ₁₇) ₃ PO ₄	Technically pure	100%	/			4	1	2	4
Turpentine Oil		Technically pure	100%	/	-	-	2	4	1	4
Urea	NH ₂ CONH ₂	Aqueous solution	<=10%	+	+	+	1	1	1	1
Urea	NH ₂ CONH ₂	Aqueous solution	33%	+	+	+	1	1	1	1
Urine Indetermined				+	+	+				
Vaseline Oil			Comm. Comp.	+	+	/		1	1	4
Vegetable Oils and fats			Comm. Comp.	+	/		1	4	1	3
Water	H ₂ O		100%	+	+	+	1	1	1	1
Water	H ₂ O		100%	+	+	+	1	1	1	1
Water	H ₂ O		100%	+	+	+	1	1	1	1
Water	H ₂ O		100%	+	+	+	2	1	2	2
Water	H ₂ O		100%	+	+	+	2	1	2	2
Water, Rain	H ₂ O		100%	+	+	+	1	1	1	1
Water, Salt	H ₂ O+NaCl		Saturated	+	+	+	1	1	1	1
Water, Sea			100%	+	+	+	1	1	1	1
Wine			Comm. Comp.	+	+	+	1	1	1	1
Wine Vinegar		Technically pure	Comm. Comp.	+	+	+				
Xylene	C ₆ H ₄ (CH ₃) ₂		100%	-	4	4	2	4		
Zinc Acetate	Zn(CH ₃ COO) ₂		Indetermined	+	+	+	2	1	4	4
Zinc Chloride	ZnCl ₂	Aqueous solution	Solution	+	+	+	2	1	1	2
Zinc Chloride	ZnCl ₂	Aqueous solution	Saturated	+	+	+	2	1	1	2
Zinc Chromate	ZnCrO ₄	Aqueous solution	Indetermined	+	+	+				
Zinc Cyanide	Zn(CN) ₂	Aqueous solution	All	+	+	+				
Zinc Nitrate	Zn(NO ₃) ₂	Aqueous solution	Indetermined	+	+	+				
Zinc Sulfate	ZnSO ₄	Aqueous solution	Solution	+	+	+	1	1	1	1
Zinc Sulfate	ZnSO ₄	Aqueous solution	Saturated	+	+	+	1	1	1	1

The data is based on the latest knowledge. When in doubt please contact our Technical Support department.



Case study
Mosaic development,
St Albans

The Mosaic developments is an exciting new development of highly specified 1 and 2 bedroom apartments, in the heart of St Albans. A kitemarked HDPE drainage system had been specified for this project, which Marley were able to supply as the HDPE system is Kitemarked BS EN1519. The HDPE range was suspended in the underground car park of this stylish 41 property complex.

HDPE handling and storage

Pipes

The high impact strength of Marley HDPE provides some protection against damage but care should be taken at all stages of handling, transportation and storage.

Pipe must be transported by a suitable vehicle and properly loaded and unloaded, e.g. wherever possible moved by hand or mechanical lifting equipment. It must not be dragged across the ground. The storage should be flat, level and free from sharp stones.

Fittings

The fittings and electrofusion couplers need to be stored in a dry place. To prevent oxidation and contamination, it is recommended to leave the fittings in their original packaging as long as possible.

Testing the system

The system should be inspected for any possible leaks in accordance with BS EN 12056. Air should be pumped into the system through a branch of a tee piece until a pressure equal to 38mm water gauge is achieved. The inlet valve should then be closed and the system should maintain the pressure for a minimum of three minutes.

Tools

All tools must be protected against moisture, dust and should not be dropped.

Storage

Bundled packs of pipe should be stored on clear, level ground with the batters supported from the outside by timber or concrete blocks. For safety, bundled packs should not be stacked more than three high.

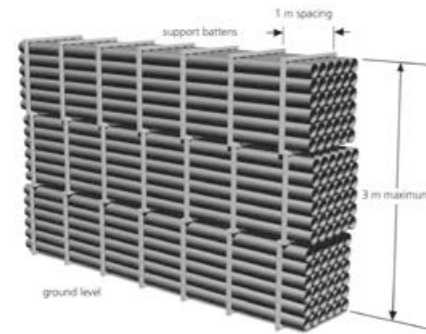

Smaller pipes may be nested inside larger pipes. Side bracing should be provided to prevent stack collapse.

Similar precautions should be taken with fittings and these should be kept packaged until required for use.

Storage of loose pipes

Pipe lengths stored individually should be stacked in a pyramid not more than one metre high, with the bottom layer fully restrained by wedges. Where possible, the bottom layer of pipes should be laid on timber battens at one-metre centres. On site, pipes may be laid out individually in strings (where appropriate, protective barriers should be placed with adequate warning signs and lamps).

Storage of loose pipes

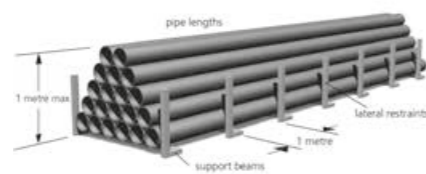

Health and safety at work act and COSHH regulations

Attention is drawn to the requirement in the UK of this act and to the 1988 Control of Substances Hazardous to Health (COSHH) Regulations. Marley cannot accept responsibility for accidents arising from the misuse of its products because of bad installation or incorrect application.

Handling of HDPE has no detrimental health impact. It is recommended, however, that HDPE is not ingested or dust inhaled.

Personal Protective Equipment (PPE)

When welding HDPE, molten material is formed, which can cause burns to skin. Appropriate PPE should be worn.

Physical contact

HDPE is not considered to be a skin irritant. Where HDPE dust is generated by cutting or machining pipe or fittings, powder particles of HDPE dust may cause eye irritation by abrasion.

THE TECHNICAL EXPERTS IN PLUMBING & DRAINAGE

Our technical team can help you specify the system you need

Years of experience mean that we can support you throughout your design process and assist with any technical and installation requirements.

- DESIGN SERVICES
- VALUE ENGINEERING
- TECHNICAL ADVICE
- FABRICATIONS SERVICE
- RAINWATER CALCULATIONS
- MATERIAL TAKE-OFFS
- CAD FILES
- BIM OBJECTS
- SPECIFICATION
- SPECIAL FABRICATIONS
- IN-HOUSE AND EXTERNAL TRAINING
- ESTIMATES



HDPE pipe subjected to extensive periods of sun can cause pipe bowing, due to single sided heating. Shielding the pipe from direct sunlight will reduce this effect.

British & European Standards

BS EN 1519-1: 2000

Plastics piping systems for soil and waste discharge (low and high temperature) within the building structure – polyethylene.

EN 12666

Plastics piping systems for non-pressure underground drainage and sewerage Polyethylene (PE) - Part 1: Specifications for pipes, fittings and the system.

EN 1053

Plastics piping systems. Thermoplastics piping systems for non-pressure applications. Test methods for water tightness.

EN 681

Elastomeric seals. Material requirements for pipe joint seals used in water and drainage applications.

BS EN ISO 9001: 2008

Quality systems. Model for Quality Assurance in Design, Development, Production, Installation and Servicing.

BS EN ISO 14001: 2004

Environmental management systems. Requirements with guidance for use.

Accreditations

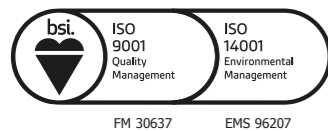

NOTE:

Marley Plumbing & Drainage products are manufactured to a constant high standard. The Company will not therefore accept responsibility for failure of any installation which includes components not supplied by us.

Customer attention is drawn to the Company's official Terms and Conditions of Sale. Goods are supplied strictly in accordance with these terms and conditions, copies of which are freely available on request and on marleypd.co.uk. Product illustrations may vary slightly depending on the type and size. Product images are for illustrative purposes only. Qty. refers to the pack quantity. Products can be purchased individually e & o e.



PVCu push-fit and solvent weld systems, ideal for domestic and commercial applications. Innovative fittings include the 8-way collar boss with top and side entries which allow for multiple inlet connections.



Certified to BS EN 1519, the Marley HDPE system offers an alternative solution to cast iron. The combination of the excellent material properties of HDPE with homogenous welded joints provide greater installation flexibility with a range of jointing options.



Used in conjunction with the acoustic pipe brackets, Marley dBlue is designed to reduce noise and acoustic vibrations to a level of 16dB at 4/s, making it perfect for multi-occupancy developments.



The Marley rainwater range comprises advanced Life4 technology, textured Foundry Finish, and profiles up to heavy industrial to make it the most comprehensive available.



Solid wall for round the house drainage with a range of adoptable inspection chambers. Quantum structured wall with smooth bore for good hydraulic performance in sewer and highway drainage applications.



Studor P.A.P.A. (Positive Air Pressure Attenuator) and Studor air admittance valves provide a complete active drainage ventilation system solution which is particularly suited to high-rise applications.



Multikwik sanitary frames and concealed cisterns deliver behind the wall reliability for wall hung toilets and basins. Glass, metal and plastic flush plates offer client choice for modern bathroom designs.

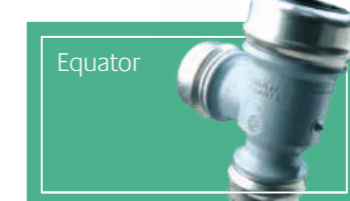

Equator is a hot & cold water system manufactured from cross-linked polyethylene (PE-X) and stainless steel. Fittings are tamperproof, but fully demountable and reusable with the use of the demounting tool.



Flowloc is a Vortex flow control unit, which is used as part of an attenuation scheme. It controls the rate at which water is discharged to a drainage system or watercourse.

MARLEY SYSTEM SOLUTIONS



marleypd.co.uk

For general enquiries and details of your nearest stockist please call the customer services department:

Tel: 01622 852585

Email: customerservice@marleypd.co.uk

To place an order

For delivery to **England & Wales**

Email: orders.lenham@marleypd.co.uk

Fax: 01622 851111

For delivery to **Scotland**

Email: orders.uddingston@marleypd.co.uk

Fax: 01698 810307

For all estimate requests

Email: estimates@marleypd.co.uk

For Technical advice please call

01622 852695

Head Office

Lenham, Maidstone

Kent ME17 2DE

Tel: 01622 858888

Fax: 01622 858725

Email: marketing@marleypd.co.uk

Scotland

Birkenshaw Industrial Estate

Uddingston, Glasgow G71 5PA

Tel: 01698 815231

Fax: 01698 810307

Export Division

Lenham, Maidstone

Kent ME17 2DE England

Tel: +44 (0)1622 858888

Fax: +44 (0)1622 850778

Email: export@marleypd.co.uk